

**DUCTING
SPECIFICATION
GUIDE
FOR EVERY
RESIDENTIAL
APPLICATION**

CONTENTS

PROUD TO BUILD BRITISH

ABOUT NUAIRE DUCTING & ANCILLARIES

3	ABOUT NUAIRE DUCTING & ANCILLARIES
4	TYPICAL NUAIRE DUCTING INSTALLATION
5	DUCTING INSTALLATION ESSENTIALS
9	FIRST FIX: FIRST FIX PLENUM BOX
10	Q-AIRE VALVES & FILTERS
13	Q-AIRE VALVES: CONSULTANT SPECIFICATION
14	Q-AIRE IAQBOX
16	Q-AIRE IAQBOX: CONSULTING SPECIFICATION
17	NUAIRE THERMAL DUCTMASTER
21	NUAIRE THERMAL DUCTMASTER RECTANGULAR
28	NUAIRE THERMAL DUCTMASTER CIRCULAR
31	DUCTMASTER RIGID
32	DUCTMASTER RIGID RECTANGULAR
44	DUCTMASTER RIGID CIRCULAR
54	DUCTMASTER RIGID PLENUMS
58	DUCTMASTER RIGID ADAPTING PIECES
65	FLEXIBLE DUCTING
69	GRILLES & DIFFUSERS
78	COWLS & TERMINALS
82	ATTENUATORS
85	DUCT ACCESSORIES
94	RADIAL RANGE

We've been pioneers in new air technology since 1966. Our heritage is in the design and manufacture of fans and ventilation systems. *We put our energy into efficient ventilation so you don't waste yours.*



Pioneering

We lead the way in product innovation with a stream of ground-breaking products over decades.



Agile

We're one of the UK's leading manufacturers, covering both residential and commercial air quality. We offer innovative advice and provide flexible solutions.



Attentive

We're expert listeners, rising to any challenge and going the extra mile for our customers. We add value by solving problems. We sell solutions, not fans.



Trusted

We have a reputation for our build quality. We establish long term relationships and are always transparent with our test data.



Expert

Our team is made up of over 600 people, 50 of which have over 25 years' experience. We have the skills and knowledge to help find the best solution for our customers.



Personal

We work closely with our customers and can provide bespoke solutions to meet their specific project needs. Many of our product ranges were developed this way.

“Our expertise, experience and innovation is what makes us stand out from the rest of the market.”

Wayne Glover, Managing Director, Nuaire.



For help with selecting a unit, speak to us on **02920 858200** or email: enquiries@nuaire.co.uk

Nuaire's range of ducting and ancillaries are designed to speed up installation, ensure optimum system performance and offer greater controllability.

We offer a comprehensive range of ducting systems and grilles for all ducted applications. Our range includes PVC rigid ducting of all types and sizes, our award-winning Nuaire Thermal Ductmaster ducting for unheated spaces, lockable valves, NOx filters and fire wraps to name a few.

We have the most innovative ducting solutions for your needs.



FLEXIBLE FITTING



SIMPLE TO INSTALL

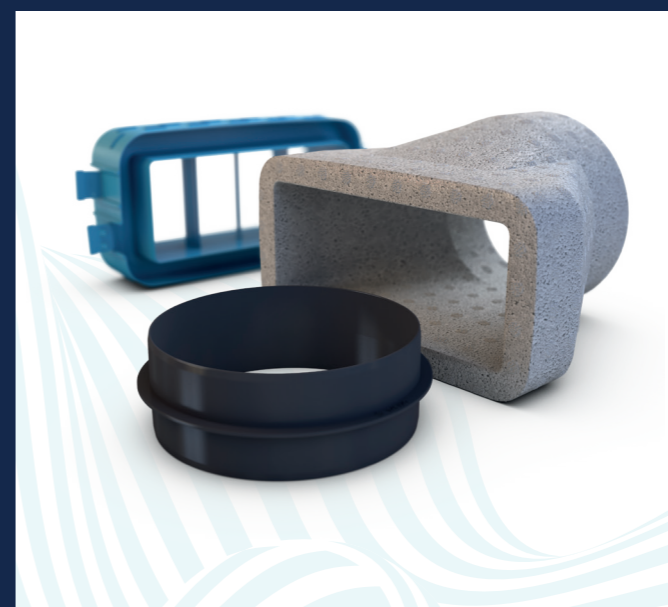
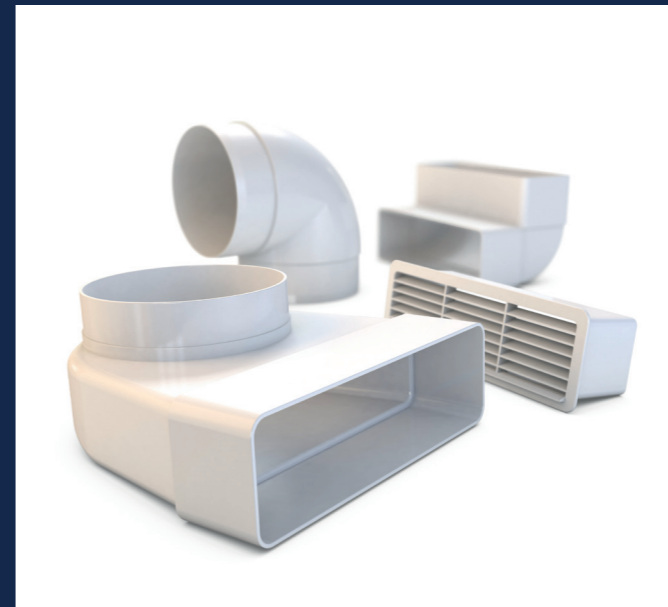

TYPICAL NUAIRE DUCTING INSTALLATION

Below is a typical MVHR installation using a mixture of Nuaire PVC and Thermal ducting. This design uses 220mm x 90mm ducting, however, a variety of ducting sizes are available for complete project flexibility.

TYPICAL NUAIRE DUCTING INSTALLATION

- PG 10 - Q-AIRE
- PG 17 - THERMAL
- PG 31 - PVC
- PG 65 - FLEXIBLE DUCTING
- PG 69 - PVC GRILLES & DIFFUSERS
- PG 92 - FIRE PROTECTION ANCILLARIES

TERMINAL OPTIONS

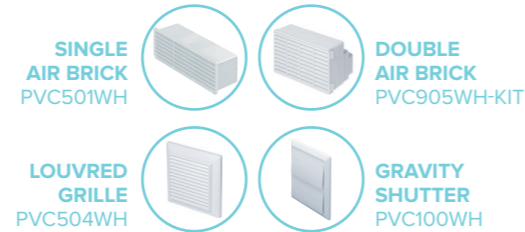

FOR MORE TERMINAL OPTIONS SEE PVC GRILLES & DIFFUSERS SECTION

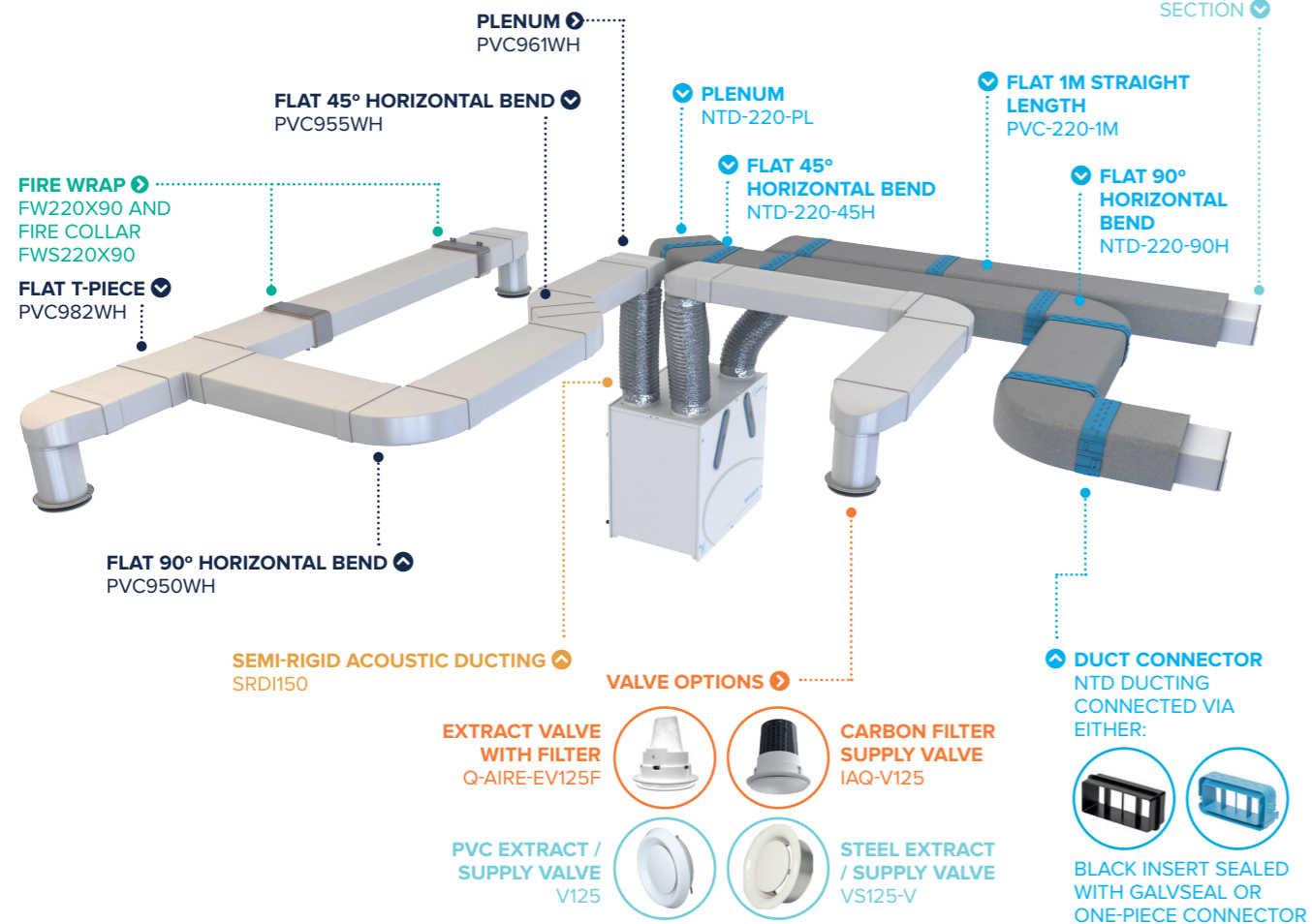

DUCTING INSTALLATION ESSENTIALS

ON SITE HELP WITH SYSTEM INSTALLATIONS

MVHR CONNECTION DETAIL

All PVC joints to be sealed with a non-hardening sealant and foil-backed tape.

Sealant and tape are not required with self seal connections or Nuaire thermal ducting.

Flexible ducting can be used for final connections or to overcome site obstructions, maximum length of 300mm per system leg.

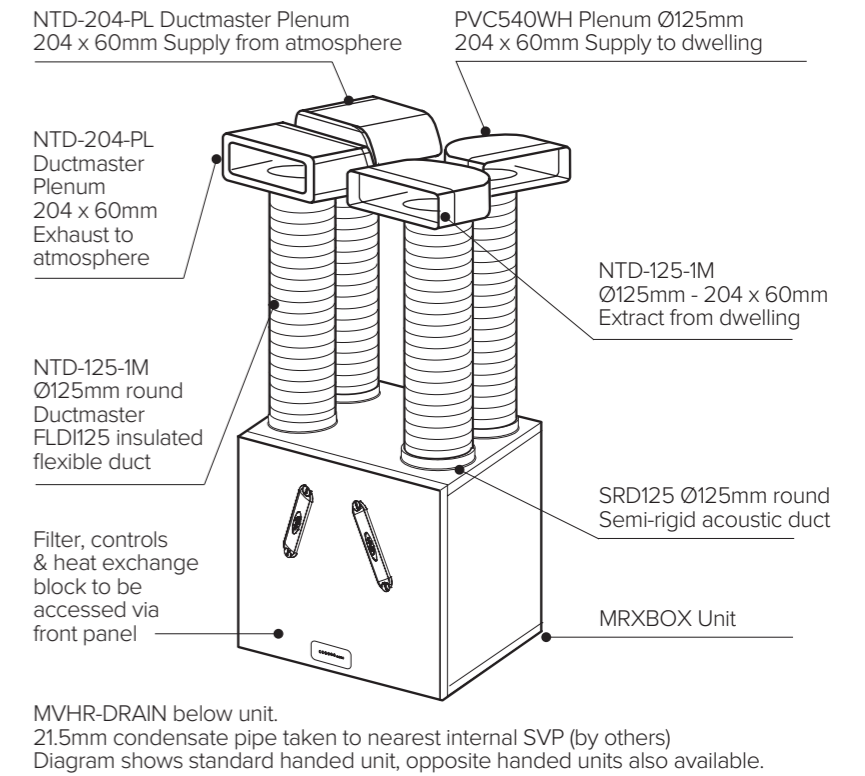

ROOF COWL INSTALLATION DETAIL

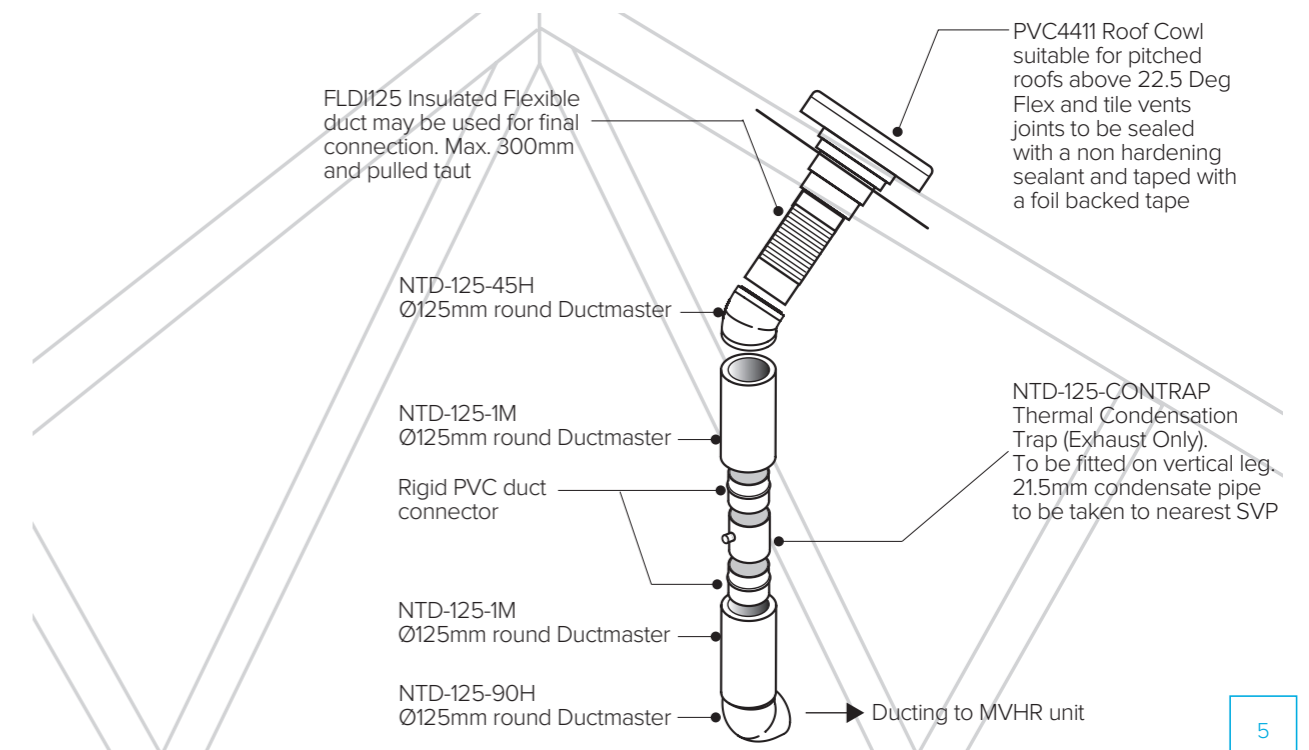

DUCTING INSTALLATION ESSENTIALS

ON SITE HELP WITH SYSTEM INSTALLATIONS

AIR BRICK CONNECTION DETAIL

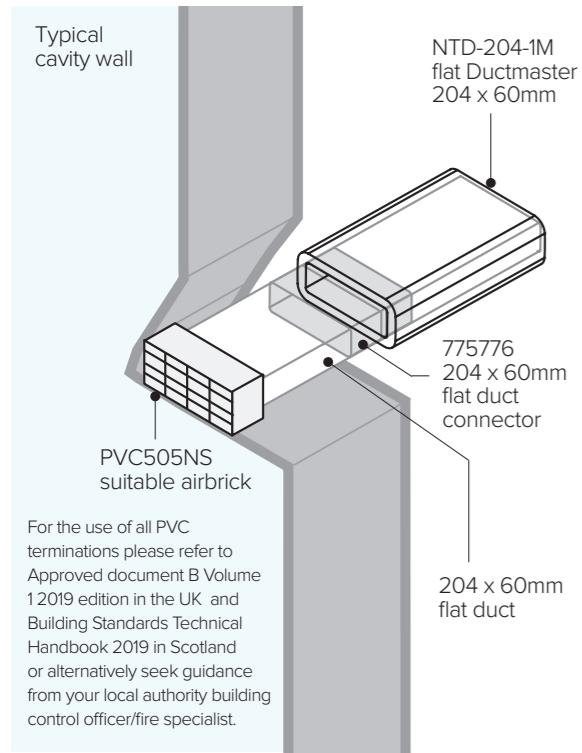

204 X 60MM DUCT SET DETAIL

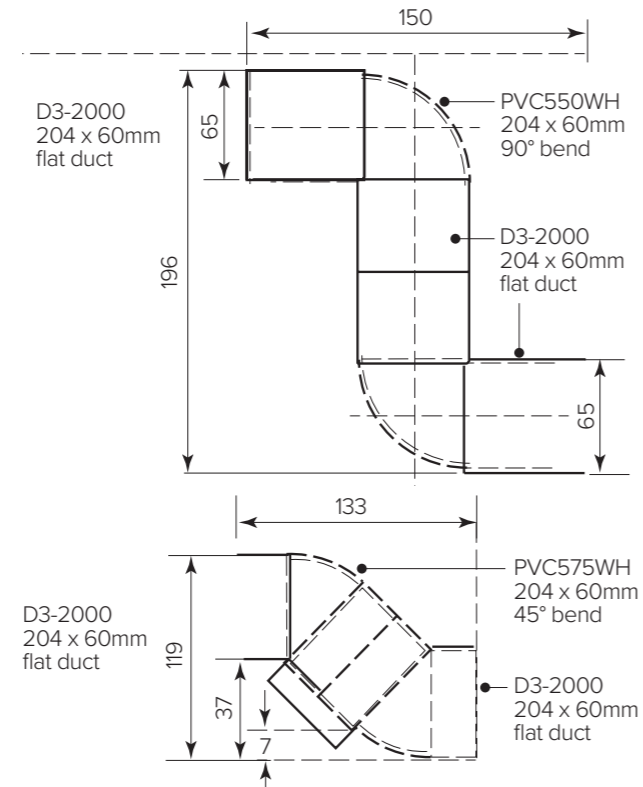

204 X 60MM ATTENUATOR IN THERMAL DUCT

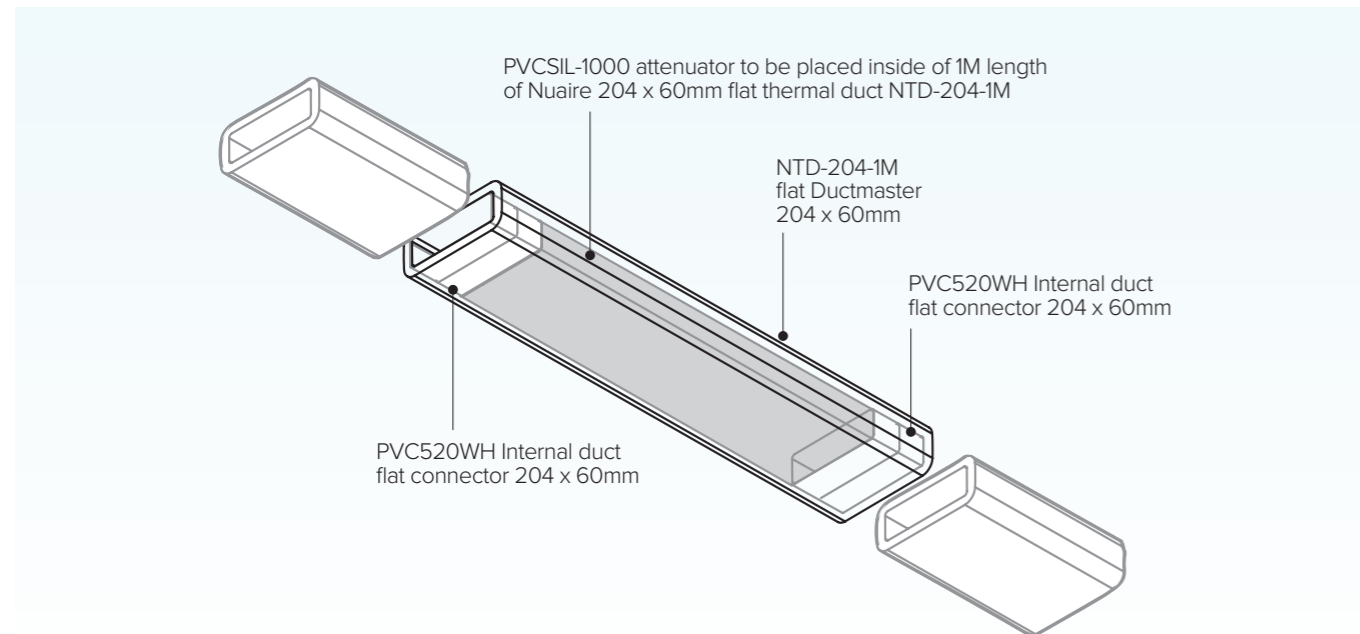

Note: Internal black connectors (041356) to be removed from thermal ducting prior to inserting attenuator

DUCTING INSTALLATION ESSENTIALS

ON SITE HELP WITH SYSTEM INSTALLATIONS

204 X 60MM FLAT THERMAL DUCT WITH FIRE DAMPER DETAIL

All joints connecting to fire dampers / fire rated air valves are to be sealed with a non-hardening, non-solvent based, intumescent mastic and foil backed tape.

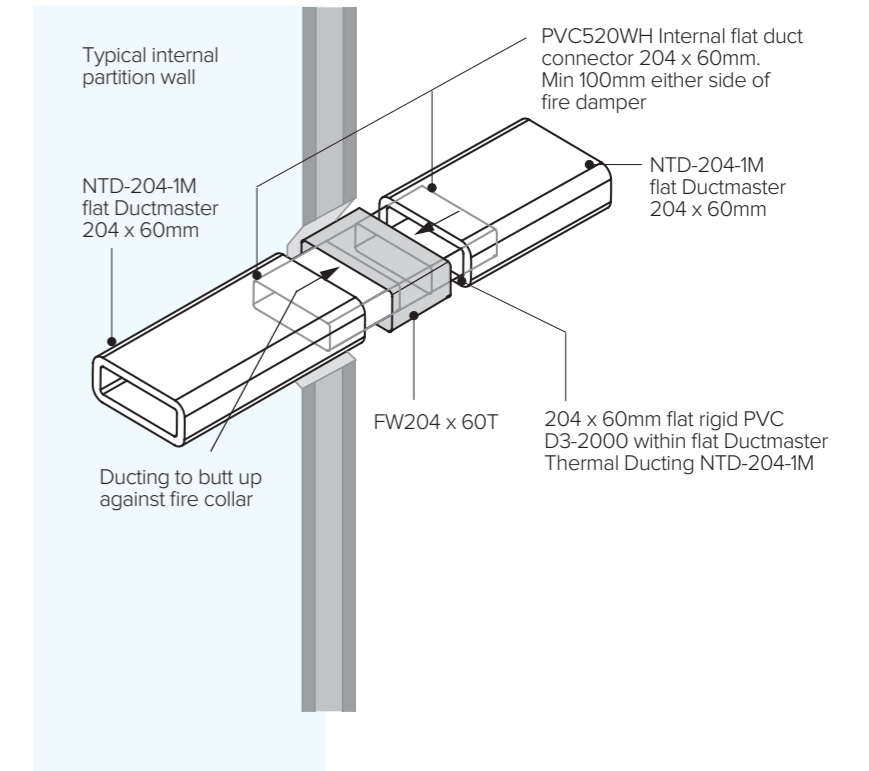

Ø125MM ROUND THERMAL DUCT WITH FIRE DAMPER DETAIL

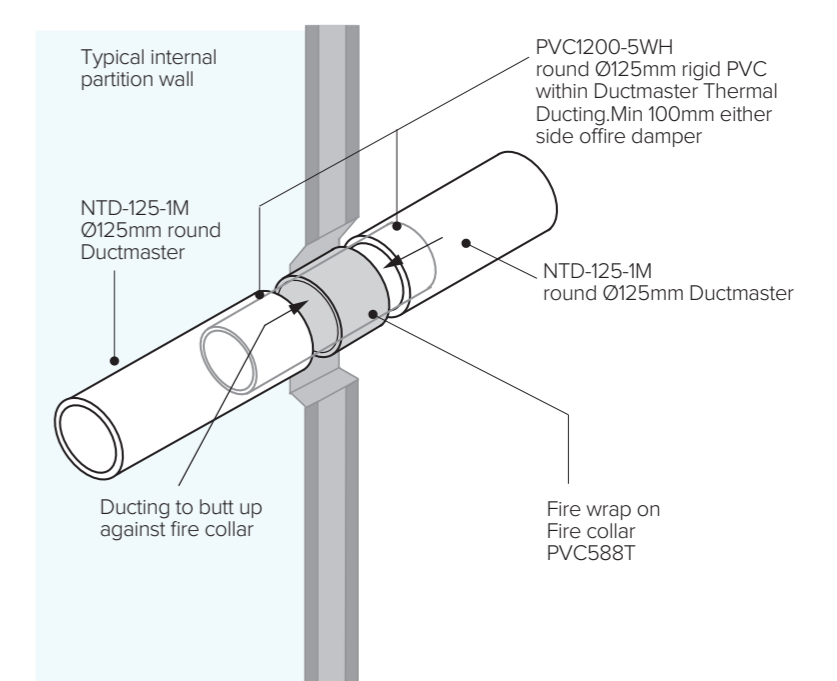

DUCTING INSTALLATION ESSENTIALS

ON SITE HELP WITH SYSTEM INSTALLATIONS

AIR VALVE DETAIL 204 X 60MM TO Q-AIRE VALVE

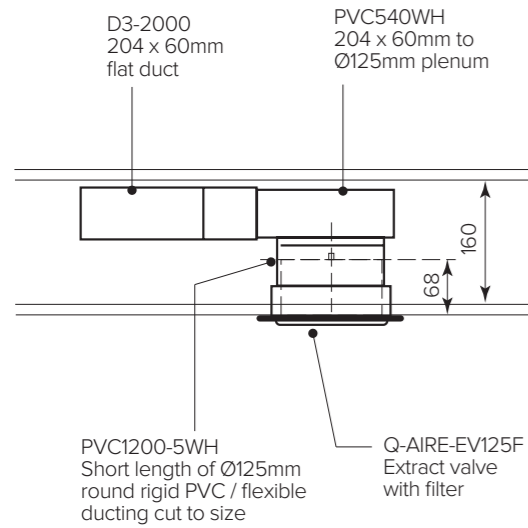

AIR VALVE DETAIL 204 X 60MM TO STEEL VALVE

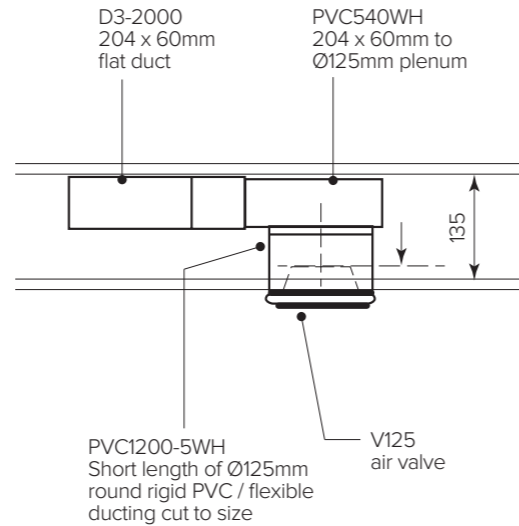

AIR VALVE DETAIL Ø125MM TO STEEL VALVE

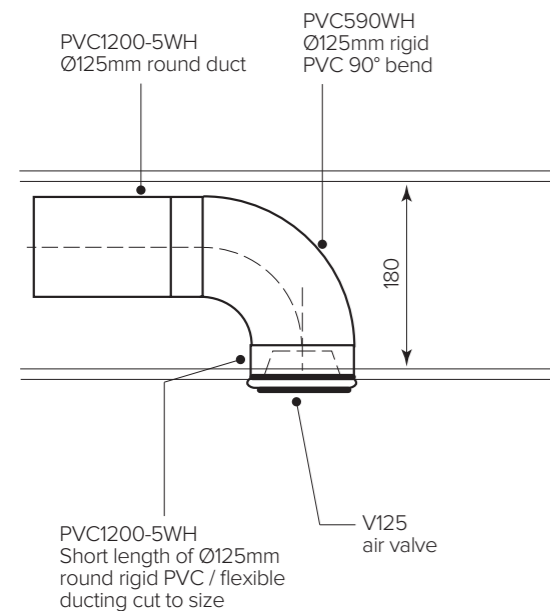

THERMAL DUCT TO AIR VALVE CONNECTION

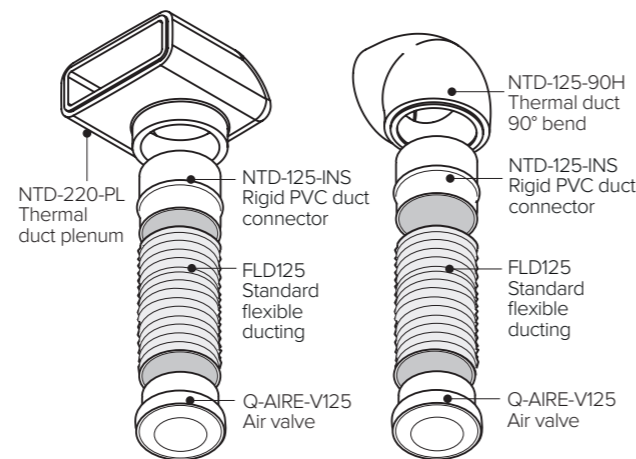

FIRST FIX

FIRST FIX PLENUM BOX

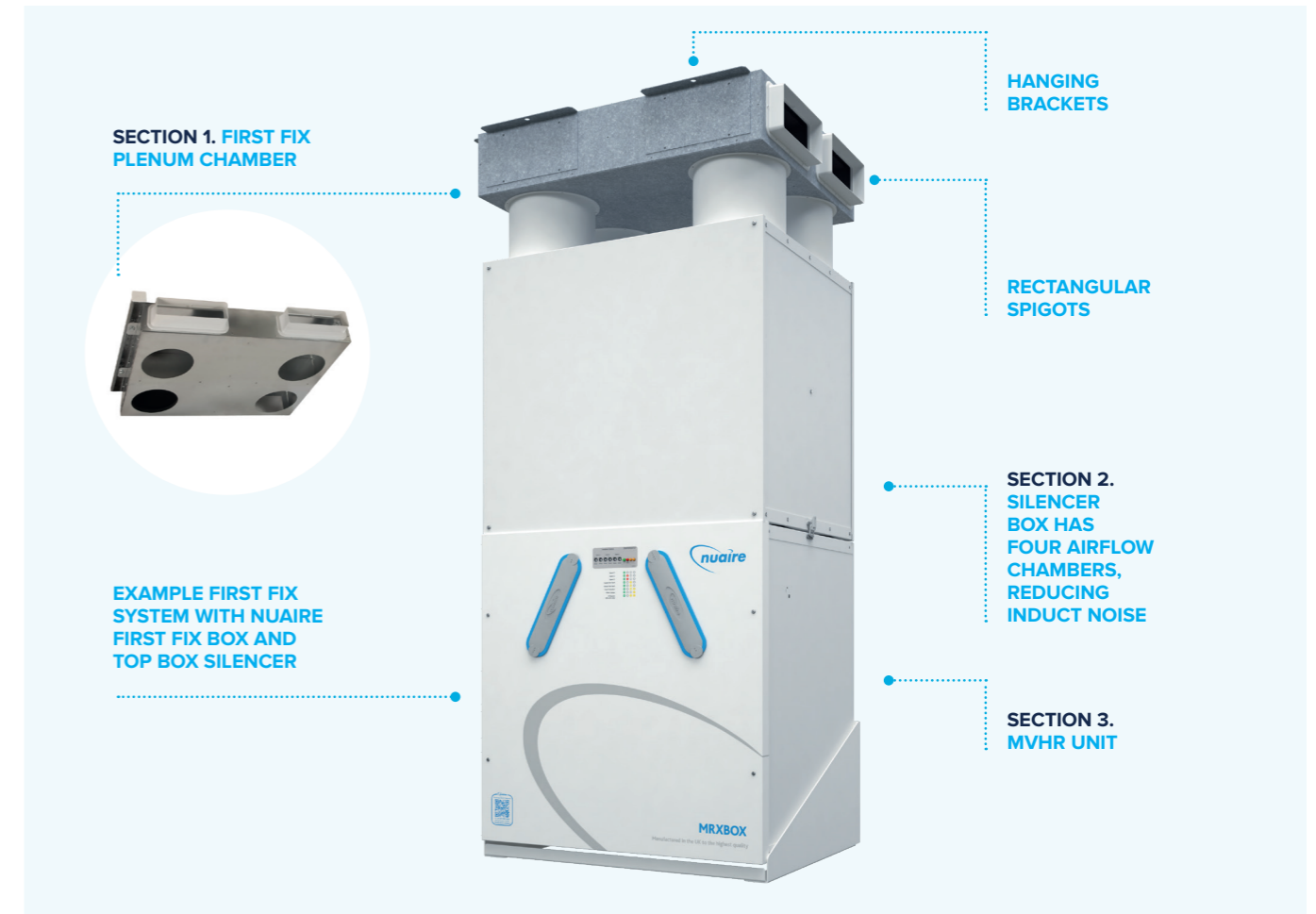

FIRST FIX PLENUM BOX

PART NUMBER	DUCT SIZE	DESCRIPTION
MRXBOX-FF5	Rect spigots: 204 x 60mm Circ spigots: Ø150mm	First fix plenum box for use with MRXBOX(AB)-ECO5 sized units
MRXBOX-FF4	Rect spigots: 220 x 90mm Circ spigots: Ø200mm	First fix plenum box for use with MRXBOX(AB)-ECO4 sized units
MRXBOX-FF3	Rect spigots: 204 x 60mm Circ spigots: Ø150mm	First fix plenum box for use with MRXBOX(AB)-ECO3 sized units
MRXBOX-FF2	Rect spigots: 204 x 60mm Circ spigots: Ø125mm	First fix plenum box for use with MRXBOX(AB)-ECO2 sized units

FIRST FIX SILENCER

PART NUMBER	DUCT SIZE	DESCRIPTION
MRXBOX-SIL5	Ø150mm	Silencer box for use with MRXBOX(AB)-ECO5 sized units
MRXBOX-SIL4	Ø200mm	Silencer box for use with MRXBOX(AB)-ECO4 sized units
MRXBOX-SIL3	Ø150mm	Silencer box for use with MRXBOX(AB)-ECO3 sized units
MRXBOX-SIL2	Ø125mm	Silencer box for use with MRXBOX(AB)-ECO2 sized units

Q-AIRE VALVES

VALVE WITHOUT FILTER

PART NUMBER	DUCT SIZE	DESCRIPTION
Q-AIRE-V125	Ø125mm Spigot	Extract/Supply Valve (White) without Airflow Filter



PART NUMBER	DUCT SIZE		RESISTANCE IN Pa							
			5l/s	10l/s	15l/s	20l/s	25l/s	30l/s	35l/s	40l/s
Q-AIRE-V125	Ø125mm Spigot	Supply	0.9	3.5	7.5	12.9	19.7	27.7	37.0	47.4
		Extract	0.8	2.7	5.7	9.8	15.1	21.7	29.6	38.9

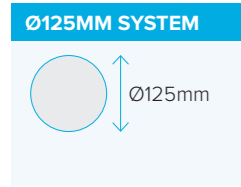

— Supply
— Extract

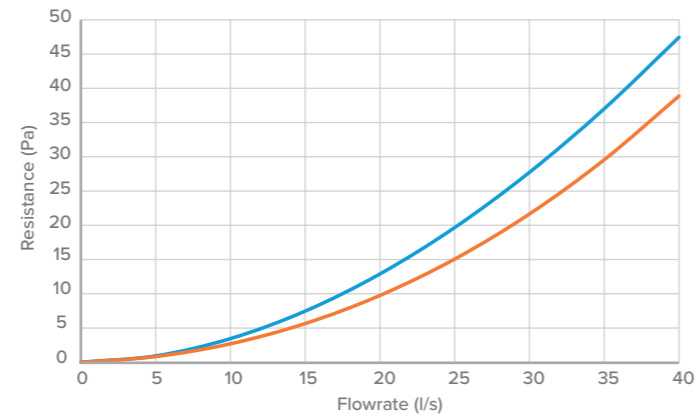

VALVE WITH FILTER AND HUMIDISTAT

PART NUMBER	DUCT SIZE	DESCRIPTION
Q-AIRE-EV125FH	Ø125mm Spigot	Extract Valve (White) with Airflow Filter and Integral Humidistat



PART NUMBER	DUCT SIZE		RESISTANCE IN Pa							
			5l/s	10l/s	15l/s	20l/s	25l/s	30l/s	35l/s	40l/s
Q-AIRE-EV125FH	Ø125mm Spigot	Supply	1.6	6.5	14.4	24.7	37.3	51.6	67.3	84.1

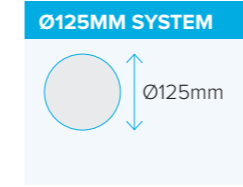

— Ø125mm Spigot

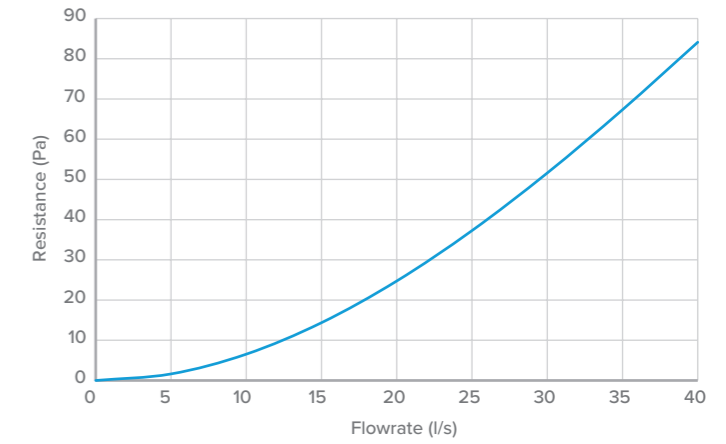

VALVE WITH FILTER

PART NUMBER	DUCT SIZE	DESCRIPTION
Q-AIRE-EV125F	Ø125mm Spigot	Extract Valve (White) with Airflow Filter



PART NUMBER	DUCT SIZE		RESISTANCE IN Pa							
			5l/s	10l/s	15l/s	20l/s	25l/s	30l/s	35l/s	40l/s
Q-AIRE-EV125F	Ø125mm Spigot	Supply	1.6	6.5	14.4	24.7	37.3	51.6	67.3	84.1

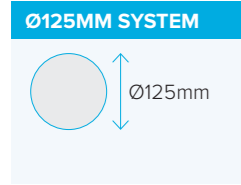

— Ø125mm Spigot

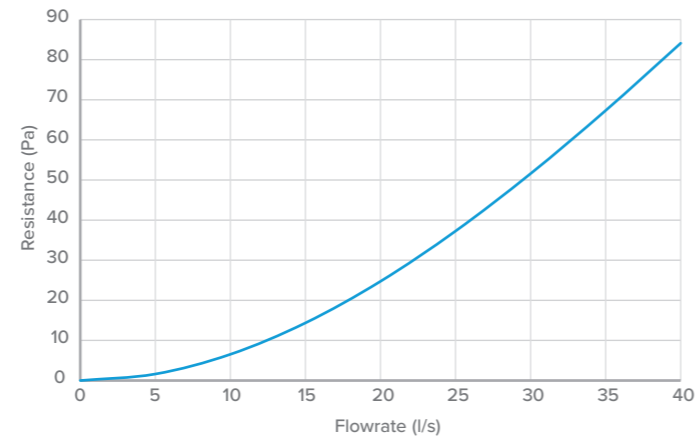

SUPPLY AIR CARBON FILTER

PART NUMBER	DUCT SIZE	DESCRIPTION
IAQ-V125	Ø125mm Spigot	Carbon Filter Supply Valve



PART NUMBER	DUCT SIZE		RESISTANCE IN Pa							
			5l/s	10l/s	15l/s	20l/s	25l/s	30l/s	35l/s	40l/s
IAQ-V125	Ø125mm Spigot	Supply	3.9	10.0	18.5	29.4	42.8	58.6	76.9	97.9

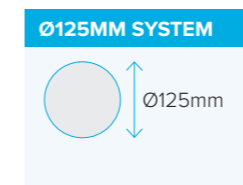

— Ø125mm Spigot

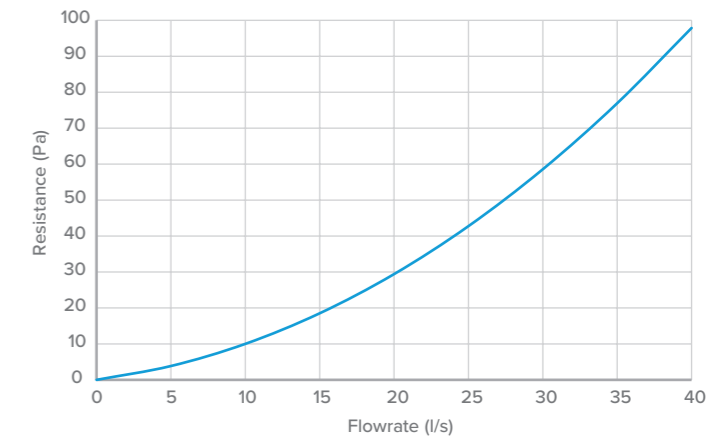

CARBON FILTER PLENUM BOX

PART NUMBER	DUCT SIZE	DESCRIPTION
IAQ-PLENUM	204mm x 60mm	Plenum box for IAQ-V125 Carbon Filter

204MM X 60MM SYSTEM

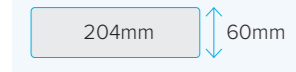

Q-AIRE VALVES

CONSULTANT SPECIFICATION

OPERATION

The supply and extract valves are used to control and distribute airflow entering or being removed from a room. They shall be capable of being used on their own, with a filter or with a filter and integral humidistat control.

Q-AIRE UNIT SPECIFICATION

Each valve shall be low profile, protruding from the ceiling by no more than 18mm when closed.

Each valve will be suitable for 125mm diameter ducting.

Each valve shall be made from flame retardant ABS plastic.

There shall be a means of adjusting the opening aperture for commissioning purpose with a decorative panel supplied to hide the commissioning screw.

The flow deflector shall be spring loaded to prevent vibration.

It shall be possible to remove/replace the bezel disc assembly within the bezel for filter access without altering the commissioned position of the valve or deflector.

Filter shall be easily removed and be of G2 grade.

The assembly shall be supplied with a deflector plate to enable air to be directed away from obstacles or to prevent air being blown in a direction which would create nuisance draughts.

An optional humidity PCB for connection to ventilation unit shall be available with set point accessible on bezel disc removal.

Humidistat PCB shall be Nuaire Ecosmart compatible.

The valve shall be offered with a 5 year warranty.

The manufacturer's recommendations should be observed at all times.

The valve shall be manufactured by Nuaire.

OPTIONS

- Three options shall be available:
- Q-AIRE-V-125 Supply & Extract Valve
 - Q-AIRE-EV125F Extract Valve with filter
 - Q-AIRE-EV125FH Extract Valve with Humidistat and Filter

IAQ UNIT SPECIFICATION

The carbon filtration for the removal of Nitrogen Dioxide shall be achieved by use of the Q-Aire carbon filter supply air valve IAQ-V125. This air valve is to be positioned in each of the habitable rooms and connected to a plenum box within the ceiling. Each air valve shall be adjustable for commissioning, with a lockable feature to ensure the commissioned airflow is always achieved.

The activated carbon shall be contained within a single cartridge that sits within the supply air valve with minimal resistance to the airflow. The activated carbon filter cartridge shall be up to 91% efficient in the removal of Nitrogen Dioxide (NO2). The filter cartridge shall be easily removable by a simple bayonet connection on the air valve assembly, ensuring a quick release and change of the filter when required. Following the replacement of the filter cartridge the air valve will not require any additional adjustment to maintain the previous designed and commissioned air flow rates.

The IAQ-V125 efficiency shall be confirmed and independently verified by a BRE (Building Research Establishment) test method and the information shall be provided by the filter manufacturer for approval.

- The valve shall be installed within a vacuum formed plenum box, suitable for 204 x 60mm ducting.
- The IAQ-V125 shall be installed in conjunction with the manufacturer's installation and maintenance guidelines.
- The valve shall be offered with a 2 year warranty; 1 year parts and labour, remaining years parts only.

Minimum life expectancy of IAQ-VALVE filters are dependent on airflow rates - 2 years up to 15l/s.

The activated carbon shall have at least the following minimum qualities:

BULK DENSITY	KG/M ³	480 (+/-5%)
Nominal Diameter of Cylindrical Pellets	Mm	4.0
Nominal Length of Cylindrical Pellets	Mm	8.0
Moisture Content (Approx.)	%	3
Crush Strength (Minimum)	Kg	2
Removal Capacity for Cl ₂ of Own Weight	%	10
Minimum Design Efficiency	%	99.5
Typical Air Velocity	M/S	0.3 – 2.5
Suitable for Relative Air Humidities	%	10 – 95
Temperature Range	°C	-20 – +51

Q-AIRE

IAQBOX

IN-LINE CARBON FILTER

PART NUMBER	DUCT SIZE	DESCRIPTION
IAQBOX-S	220mm x 90mm	In-Line Single Carbon Filter



PART NUMBER	DUCT SIZE	RESISTANCE IN Pa											
		5l/s	10l/s	15l/s	20l/s	25l/s	30l/s	35l/s	40l/s	50l/s	60l/s	70l/s	80l/s
IAQBOX-S	220mm x 90mm	1.8	4.2	7.2	10.8	15.1	20.0	20.5	31.7	45.9	62.8	82.3	104.5

220MM X 90MM SYSTEM

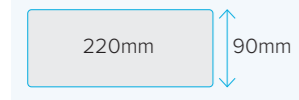

— 220x90mm

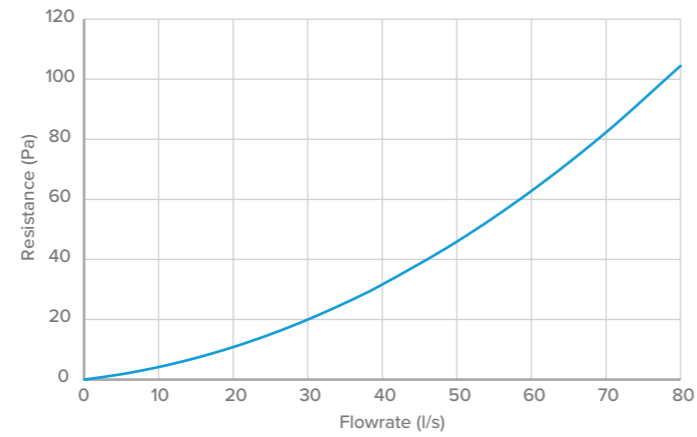

IN-LINE SINGLE CARBON FILTER WITH PM2.5

PART NUMBER	DUCT SIZE	DESCRIPTION
IAQBOX-S-PM2.5	220mm x 90mm	In-Line Single Carbon Filter with Pm2.5 Filter



PART NUMBER	DUCT SIZE	RESISTANCE IN Pa											
		5l/s	10l/s	15l/s	20l/s	25l/s	30l/s	35l/s	40l/s	50l/s	60l/s	70l/s	80l/s
IAQBOX-S-PM2.5	220mm x 90mm	5.9	12.5	20.0	28.1	37.1	46.7	57.1	68.1	92.3	119.2	148.7	180.6

220MM X 90MM SYSTEM

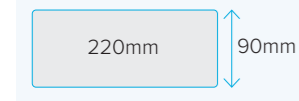

— 220x90mm

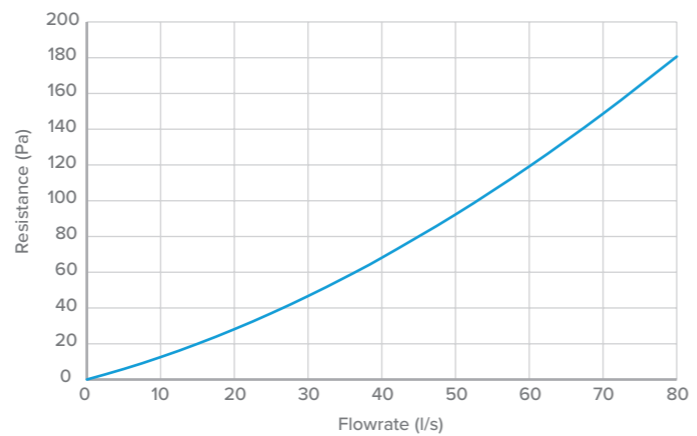

IN-LINE CARBON FILTER

PART NUMBER	DUCT SIZE	DESCRIPTION
IAQBOX-D	220mm x 90mm	In-Line Double Carbon Filter



PART NUMBER	DUCT SIZE	RESISTANCE IN Pa													
		5l/s	10l/s	15l/s	20l/s	25l/s	30l/s	35l/s	40l/s	50l/s	60l/s	70l/s	80l/s		
IAQBOX-D	220mm x 90mm	1 Spigot	0.7	1.8	3.1	4.7	6.6	8.8	11.2	13.8	19.8	26.7	34.3	42.7	
		2 Spigots	0.7	1.6	2.6	3.8	5.1	6.5	8.1	9.9	13.8	18.4	23.5	29.1	

220MM X 90MM SYSTEM

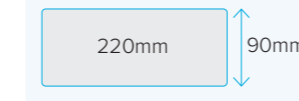

— Using one outlet spigot
— Using two outlet spigots

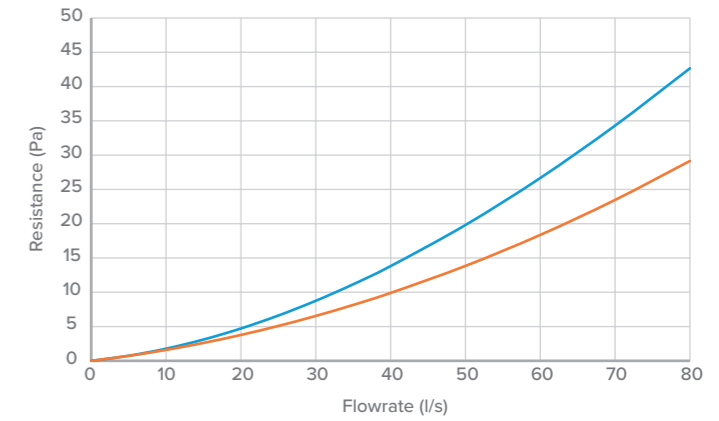

IN-LINE DOUBLE CARBON FILTER WITH PM2.5

PART NUMBER	DUCT SIZE	DESCRIPTION
IAQBOX-D-PM2.5	220mm x 90mm	In-Line Double Carbon Filter with Pm2.5 Filter



PART NUMBER	DUCT SIZE	RESISTANCE IN Pa													
		5l/s	10l/s	15l/s	20l/s	25l/s	30l/s	35l/s	40l/s	50l/s	60l/s	70l/s	80l/s		
IAQBOX-D-PM2.5	220mm x 90mm	1 Spigot	2.7	5.8	9.3	13.1	17.2	21.6	26.4	31.4	42.4	54.4	67.4	81.3	
		2 Spigots	2.9	5.9	9.2	12.5	16.1	19.9	23.8	28.0	36.9	46.7	57.4	69.0	

220MM X 90MM SYSTEM

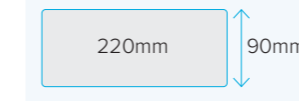

— Using one outlet spigot
— Using two outlet spigots

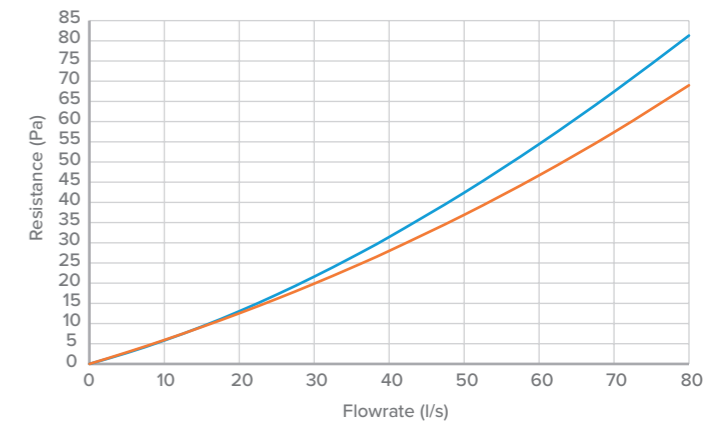

Q-AIRE IAQBOX CONSULTANT SPECIFICATION



UNIT SPECIFICATION

The IAQBOX-S and IAQBOX-D (plus pre-filter variant codes) comprise the Q-Aire IAQBOX range and shall be manufactured in galvanised sheet metal, with an integral foam lining to reduce noise & provide internal sealing. Each in-line filter shall have the ability to have an optional PM2.5 pre-filter inserted into the filter box to be capable of additional particulate filtration; particularly from diesel vehicle fumes.

The IAQBOX shall come complete with a removable mounting bracket.

The double size IAQBOX-D range of units have the option to be configured using a single or double spigot on the outlet. Double spigot on the outlet shall provide lower air resistance and further ducting options.

The IAQBOX shall come complete with a single cartridge of plastic construction, containing two 30mm (approx.) beds of activated carbon pellets providing a large surface area of carbon to attract pollutants. The filters shall be easily removed and replaced when required. The filter shall have a minimum efficiency of between 96% and 99.5% effectiveness in the removal of Nitrogen Oxides/Dioxides.

The unit efficiency shall be confirmed and independently verified by a BRE (Building Research Establishment) test method and the information shall be provided by the filter manufacturer for approval.

The activated carbon shall have at least the following minimum qualities:

BULK DENSITY	KG/M ³	480 (+/-5%)
Nominal Diameter of Cylindrical Pellets	mm	4.0
Nominal Length of Cylindrical Pellets	mm	8.0
Moisture Content (Approx.)	%	3
Crush Strength (Minimum)	KG	2
Removal Capacity For Cl ₂ of Own Weight	%	10
Minimum Design Efficiency	%	99.5
Typical Air Velocity	M/S	0.3 – 2.5
Suitable for Relative Air Humidities	%	10 – 95
Temperature Range	°C	-20 – +51

The unit shall be suitable for 220x90mm ducting.

The unit shall be installed in conjunction with the manufacturer's installation and maintenance guidelines.

The unit shall be offered with a 4 year warranty; 1 year parts and labour, remaining years parts only. This warranty is void if the equipment is modified without authorisation, is incorrectly applied, misused, disassembled or not installed, commissioned and maintained in accordance with the details contained in the I&M manual and general good practice.

Minimum life expectancy of IAQBOX filters are dependent on airflow rates.

IAQBOX-S

- 4 years up to 40l/s
- 2 years over 40l/s

IAQBOX-D

- 4 years

NUAIRE THERMAL

Nuaire Thermal Ductmaster (NTD) is an all-in-one insulated ducting solution, manufactured from graphite polystyrene. Lightweight and airtight due to a unique clip system, NTD is easy to install and requires no sealant or tape.

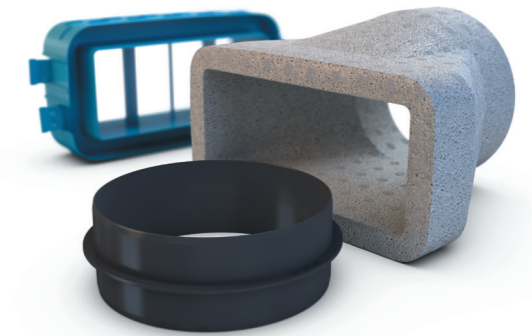

HIGH THERMAL EFFICIENCY

Most cost-effective solution on the market.



QUICK AND EASY INSTALLATION

Simple, quick-fit components means less time spent on site.



COST EFFECTIVE SOLUTION

All-in-one system, no need for additional installation.



ENVIRONMENTALLY FRIENDLY

Ducting exceeds regulatory insulation requirements.



INDEPENDENTLY TESTED FOR AIR-TIGHTNESS BY THE BRE.

DESCRIPTION

A range of ducting and ancillaries intended for installation in domestic properties. Nuaire Thermal is available in two sizes, based on the internal dimension: Ø125mm or 204mm x 60mm.

MATERIAL

Graphite impregnated expandable polystyrene (EPS). Tradename – BASF Neopor® 2300.

THERMAL PROPERTIES

Thickness	20mm nominal
Density	25kg/m ³
Thermal Conductivity	K = 0.03W/m.k
Thermal Resistance	R = material thickness/thermal conductivity. R = 0.67 (m ² .k)/W
U Value (1/R)	1.49 W/(m ² .K)



INDEPENDENTLY TESTED FOR THERMAL CONDUCTIVITY BY BASF, GERMANY.

BUILDING REGULATIONS

Domestic ventilation compliance guide requires insulation of the ducting to be n equivalent of at least 25mm of a material having a thermal conductivity of <=0.04 W/m.k.

Therefore

Thermal resistance, R = 0.025/0.04

R = 0.625 (m².k)/W

U Value (1/R) = 1.6W/(m².k)

FLAMMABILITY

Class E to BS EN 13501-1 Fire classification of construction products and building elements.

FLEXIBLE DUCT CONNECTIONS BETWEEN AIR VALVES AND PLENUMS/BENDS

FIGURE 4: TYPICAL FLEXIBLE DUCTING BETWEEN AIR VALVE AND PLENUM BEND

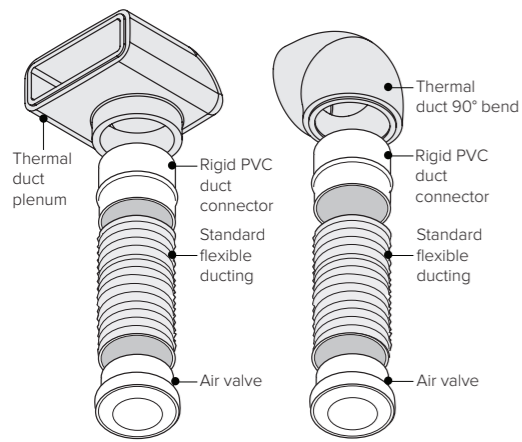

AIR BRICK CONNECTION DETAIL

FIGURE 5: TYPICAL RECTANGULAR THERMAL DUCT WITH AN AIR BRICK

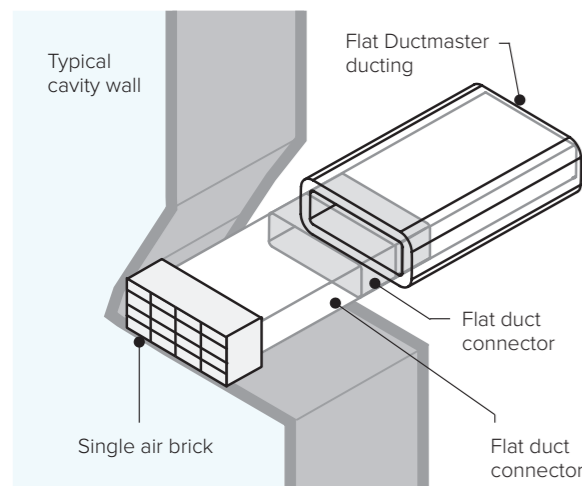

*For the use of all PVC terminations please refer to Approved document B Volume 1 2019 edition in the UK and Building Standards Technical Handbook 2019 in Scotland or alternatively seek guidance from your local authority building control officer/fire specialist.

CONDENSATE TRAP IN THERMAL DUCTING

FIGURE 6: CONDENSATE TRAP WITH RIGID PVC DUCT CONNECTORS

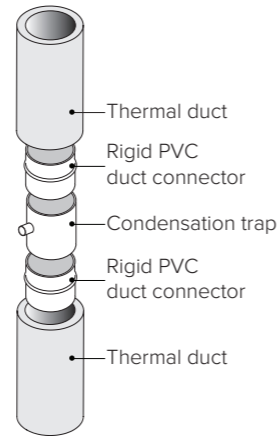

FIRE WRAP IN THERMAL DUCTING

FIGURE 7: FIRE WRAP IN RECTANGULAR THERMAL DUCTING

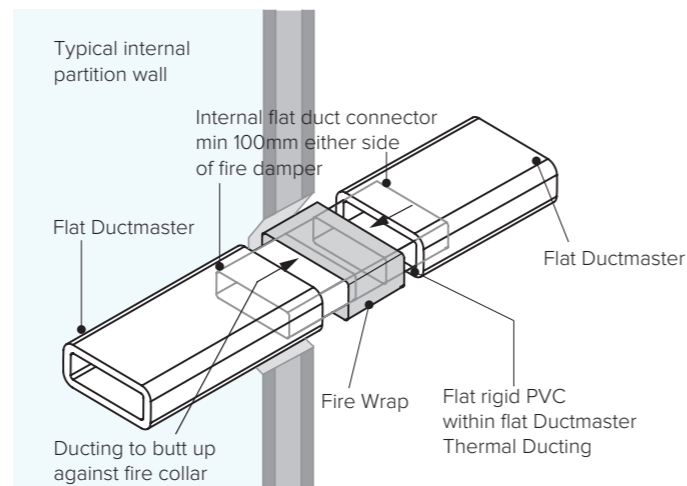

ATTENUATOR IN THERMAL DUCTING

FIGURE 8: TYPICAL RECTANGULAR THERMAL DUCT WITH AN ATTENUATOR

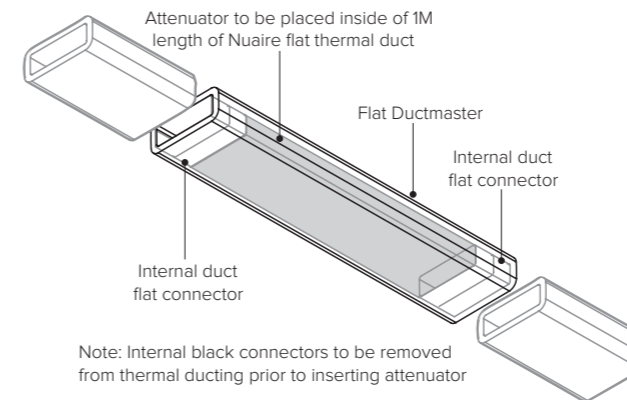

CUTTING DUCTING

A flush, square 90° cut is required to ensure that an airtight seal is made with centre ridge in the clamp. In an angled cut is made, this will not allow the duct clamps to create a seal on the duct.

We advise that the duct is cut with a very sharp blade or fine toothed saw (we recommend a minimum of 14 teeth per inch). The cutting blade length should be at least the same length as the thickness of the ducting.

Ensure duct is placed into a duct clamp connector prior to installation to check the cut ducting is square.

FIGURE 9A: A SQUARE 90° CUT IS REQUIRED TO ENSURE AN AIRTIGHT SEAL

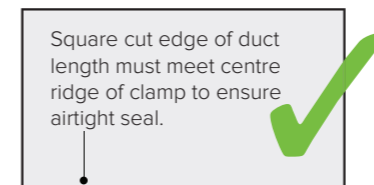

FIGURE 9B: NON SQUARE CUT RESULTING IN AIR LEAKAGE FROM DUCT

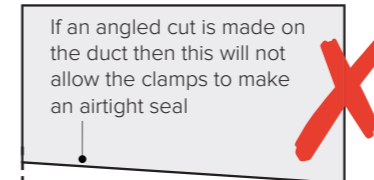
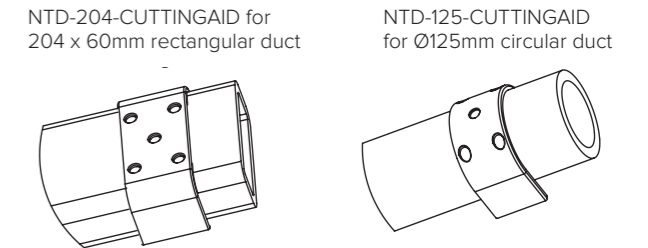

FIGURE 10: CUTTING AIDS AVAILABLE FROM NUAIRE



FITTING CLAMPS

For installation into the duct clamp, push the two pre-cut lengths of ducting firmly into the clamp at opposite ends. **Double check the cut ducting is square. Failing to do so may cause air leakage.**

The centre joint of the duct should be located on the centre flange of the clamp. **Ensure the ducting is fully pressed into the clamp to create an airtight seal. Failing to do so may cause air leakage.**

Press the fixing tabs down until they lock in place.

Important: NTD is supplied in 1 metre lengths. If shorter lengths are required the duct can be cut to length with a fine toothed saw (minimum of 14 teeth per inch).
Failure to make a square cut may result in airflow leakage when connecting to other ducting pieces. Ensure the duct is placed into a duct clamp prior to installation to check the cut ducting is square.

FIGURE 11: FITTING RECTANGULAR AND CIRCULAR DUCT CLAMP

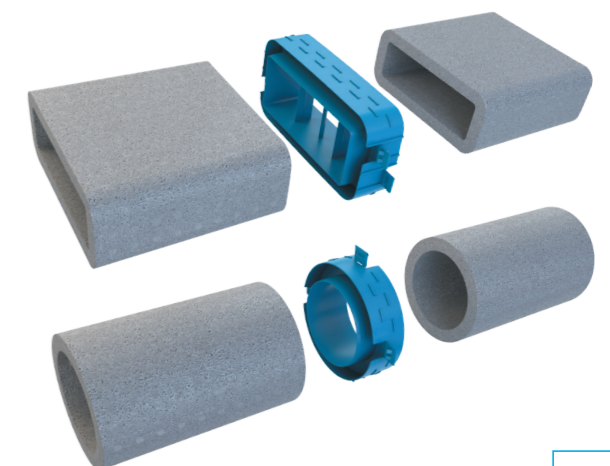

INSTALLATION USING BLACK INNER CONNECTIONS AND SEALANT

For connection of thermal ducting with inner duct connectors, we recommend the use of Galva Mate, solvent free, low-odour sealant. Sealant should be applied in the middle of the connection face with a minimum bead width of 5mm. Fit ducting over connector, ensuring end face butts up to the connector shoulder. Allow minimum of 1 hour curing time at room temperature.

FIGURE 12: FITTING PVC BAND

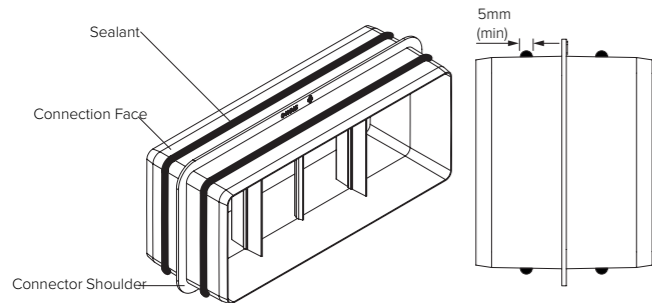
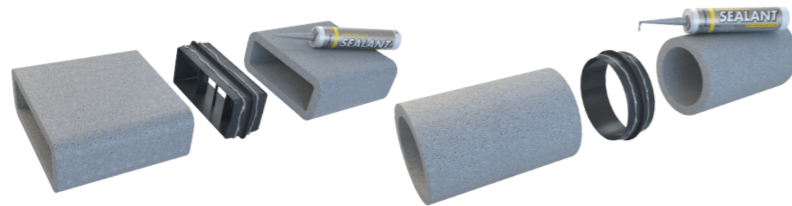

FIGURE 13: RECTANGULAR AND CIRCULAR DUCT BLACK INSERT INSTALLATION



FITTING DUCT BANDING

For installation onto a solid surface, suitable duct banding must be used to support both the rectangular and circular ducting and should be fitted every 1m. When fitting the bands at the fixing clamps, the raised tabs provided will act as an installation guide. Nuair recommends the use of PVC coated galvanised banding available under item code: PVCBAND. As an alternative, uncoated galvanised banding may also be used. Note, in both case, if banding is used on the duct itself and not at the fixing clamp then care should be taken to ensure the banding does not cut into the surface as this may cause damage and ultimately lead to leakage.

FIGURE 14: FITTING DUCT BANDING

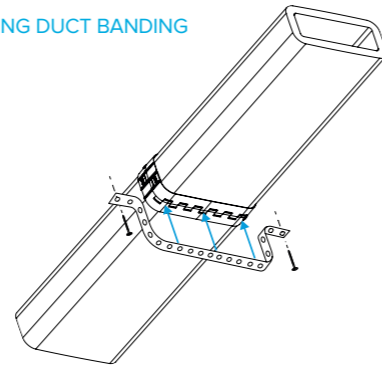

NUAIRE THERMAL DUCTMASTER

RECTANGULAR

THERMAL 1M LENGTH

CODE	DUCT SIZE	DESCRIPTION	MATERIAL	COLOUR	FLAMMABILITY RATING	MANUFACTURED TO
NTD-220-1M	220mm x 90mm x 20mm	Thermal rectangular ducting length 1m	GPS (Graphite Polystyrene)	Grey	Class E to BS EN 13501-1	ISO9001
NTD-204-1M	204mm x 60mm x 20mm	Thermal rectangular ducting length 1m	GPS (Graphite Polystyrene)	Grey	Class E to BS EN 13501-1	ISO9001

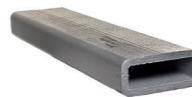

PART NUMBER	DUCT SIZE	RESISTANCE IN Pa											
		5l/s	10l/s	15l/s	20l/s	25l/s	30l/s	35l/s	40l/s	50l/s	60l/s	70l/s	80l/s
NTD-220-1M	220mm x 90mm	0.0	0.1	0.1	0.2	0.2	0.3	0.4	0.6	0.8	1.2	1.6	2.0
NTD-204-1M	204mm x 60mm	0.1	0.3	0.5	0.8	1.2	1.6	2.1	2.6	3.7	4.9	6.3	7.8

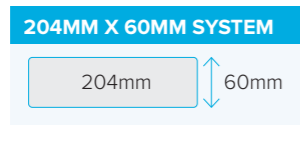
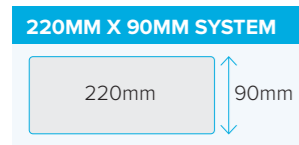

- 220x90mm
- 204x60mm

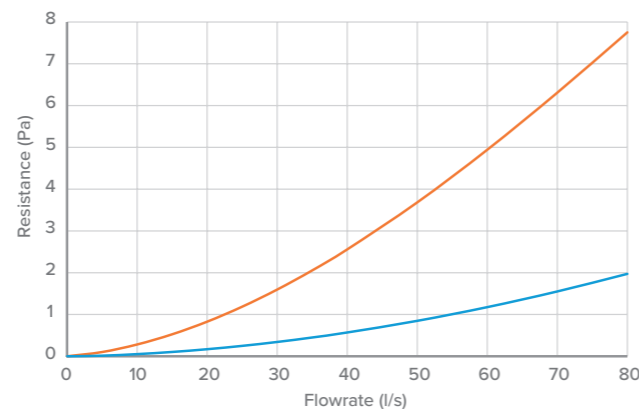

NUAIRE THERMAL DUCTMASTER

RECTANGULAR

THERMAL HORIZONTAL T-PIECE

CODE	DUCT SIZE	DESCRIPTION	MATERIAL	COLOUR	FLAMMABILITY RATING	MANUFACTURED TO
NTD-220-TP	220mm x 90mm	Thermal rectangular horizontal T-piece	GPS (Graphite Polystyrene)	Grey	Class E to BS EN 13501-1	ISO9001
NTD-204-TP	204mm x 60mm	Thermal rectangular horizontal T-piece	GPS (Graphite Polystyrene)	Grey	Class E to BS EN 13501-1	ISO9001

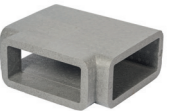

PART NUMBER	DUCT SIZE	RESISTANCE IN Pa											
		5l/s	10l/s	15l/s	20l/s	25l/s	30l/s	35l/s	40l/s	50l/s	60l/s	70l/s	80l/s
NTD-220-TP	220mm x 90mm Equal T Piece A-B	0.0	0.2	0.6	1.1	1.8	2.6	3.6	4.7	7.3	10.4	14.1	18.1
	220mm x 90mm Equal T Piece A-C	0.1	0.2	0.4	0.6	0.8	1.2	1.6	2.0	3.0	4.2	5.6	7.1

220MM X 90MM SYSTEM

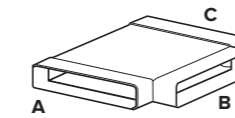

- 220x90mm Equal T Piece A-B
- 220x90mm Equal T Piece A-C

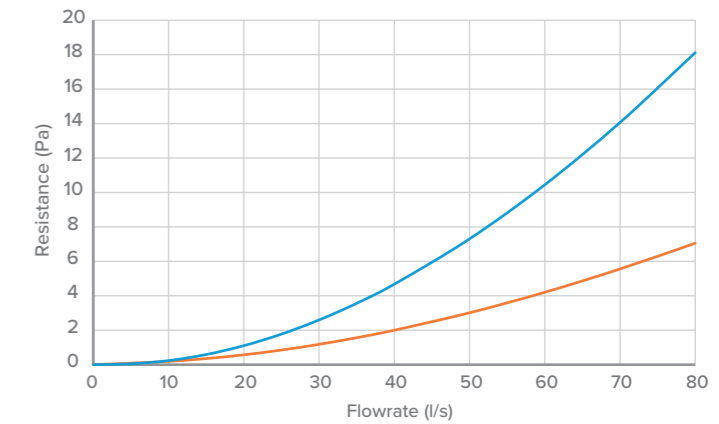

PART NUMBER	DUCT SIZE	RESISTANCE IN Pa											
		5l/s	10l/s	15l/s	20l/s	25l/s	30l/s	35l/s	40l/s	50l/s	60l/s	70l/s	80l/s
NTD-204-TP	204mm x 60mm Equal T Piece A-B	0.1	0.3	1.1	2.1	3.5	5.3	7.3	9.7	15.4	22.3	30.4	39.6
	204mm x 60mm Equal T Piece A-C	0.0	0.1	0.3	0.6	1.1	1.7	2.4	3.2	5.2	7.7	10.6	13.9

204MM X 60MM SYSTEM

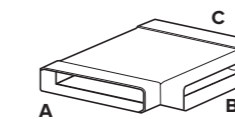
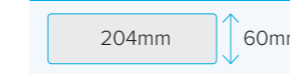

- 204x60mm Equal T Piece A-B
- 204x60mm Equal T Piece A-C

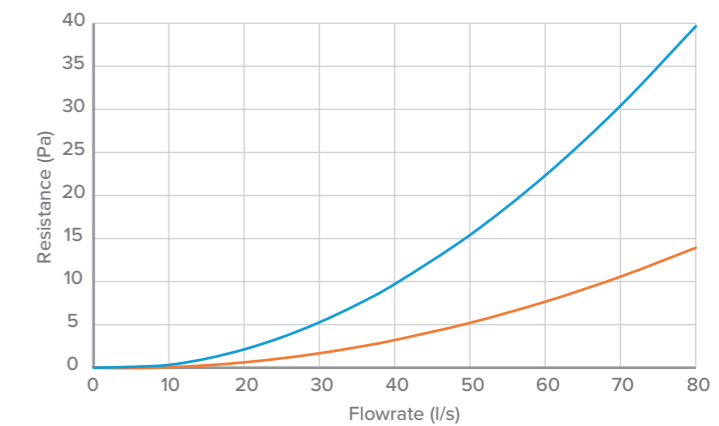

THERMAL 90° HORIZONTAL BEND

CODE	DUCT SIZE	DESCRIPTION	MATERIAL	COLOUR	FLAMMABILITY RATING	MANUFACTURED TO
NTD-220-90H	220mm x 90mm	Thermal 90° horizontal bend	GPS (Graphite Polystyrene)	Grey	Class E to BS EN 13501-1	ISO9001
NTD-204-90H	204mm x 60mm	Thermal 90° horizontal bend	GPS (Graphite Polystyrene)	Grey	Class E to BS EN 13501-1	ISO9001



PART NUMBER	DUCT SIZE	RESISTANCE IN Pa												
		5l/s	10l/s	15l/s	20l/s	25l/s	30l/s	35l/s	40l/s	50l/s	60l/s	70l/s	80l/s	
NTD-220-90H	220mm x 90mm	0.1	0.3	0.6	1.0	1.5	2.1	2.8	3.6	5.5	7.8	10.6	13.7	
NTD-204-90H	204mm x 60mm	0.3	0.9	1.7	2.9	4.4	6.3	8.4	10.9	16.8	24.0	32.7	42.7	

220MM X 90MM SYSTEM

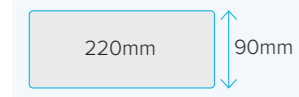

204MM X 60MM SYSTEM

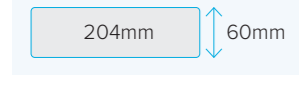

- 220x90mm
- 204x60mm

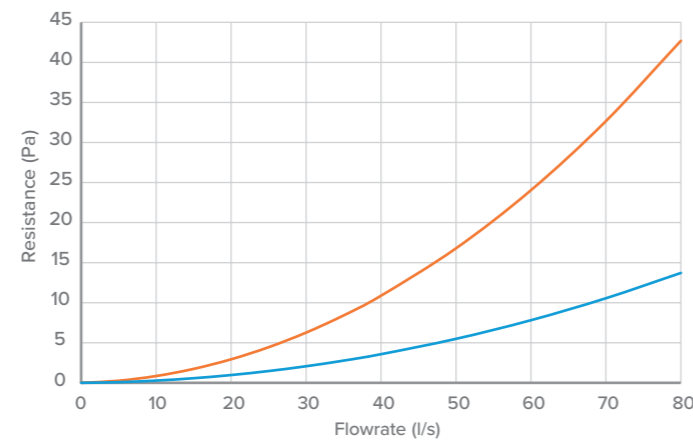

THERMAL 45° HORIZONTAL BEND

CODE	DUCT SIZE	DESCRIPTION	MATERIAL	COLOUR	FLAMMABILITY RATING	MANUFACTURED TO
NTD-220-45H	220mm x 90mm	Thermal 45° horizontal bend	GPS (Graphite Polystyrene)	Grey	Class E to BS EN 13501-1	ISO9001
NTD-204-45H	204mm x 60mm	Thermal 45° horizontal bend	GPS (Graphite Polystyrene)	Grey	Class E to BS EN 13501-1	ISO9001



PART NUMBER	DUCT SIZE	RESISTANCE IN Pa												
		5l/s	10l/s	15l/s	20l/s	25l/s	30l/s	35l/s	40l/s	50l/s	60l/s	70l/s	80l/s	
NTD-220-45H	220mm x 90mm	0.0	0.1	0.2	0.3	0.4	0.6	0.8	1.0	1.6	2.4	3.3	4.4	
NTD-204-45H	204mm x 60mm	0.1	0.2	0.5	0.9	1.3	1.9	2.5	3.2	5.0	7.2	9.8	12.8	

220MM X 90MM SYSTEM

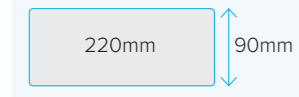

204MM X 60MM SYSTEM

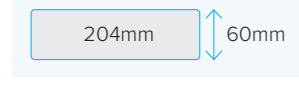

- 220x90mm
- 204x60mm

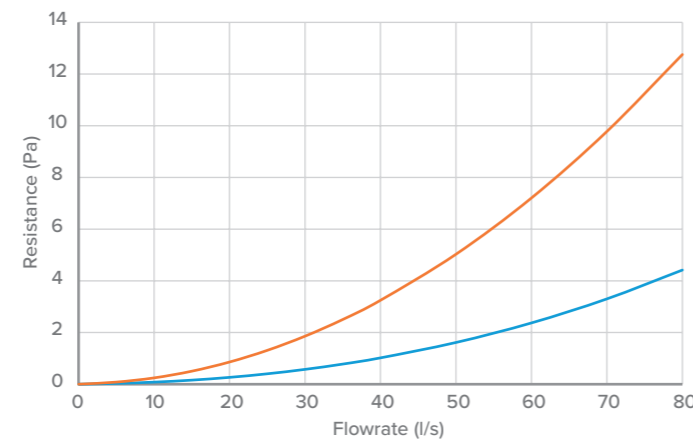

THERMAL 90° VERTICAL BEND

CODE	DUCT SIZE	DESCRIPTION	MATERIAL	COLOUR	FLAMMABILITY RATING	MANUFACTURED TO
NTD-220-90V	220mm x 90mm	Thermal 90° vertical bend	GPS (Graphite Polystyrene)	Grey	Class E to BS EN 13501-1	ISO9001
NTD-204-90V	204mm x 60mm	Thermal 90° vertical bend	GPS (Graphite Polystyrene)	Grey	Class E to BS EN 13501-1	ISO9001



PART NUMBER	DUCT SIZE	RESISTANCE IN Pa												
		5l/s	10l/s	15l/s	20l/s	25l/s	30l/s	35l/s	40l/s	50l/s	60l/s	70l/s	80l/s	
NTD-220-90V	220mm x 90mm	0.1	0.3	0.5	0.8	1.2	1.7	2.3	3.0	4.6	6.5	8.9	11.6	
NTD-204-90V	204mm x 60mm	0.2	0.7	1.4	2.4	3.6	5.1	6.9	8.9	13.8	19.7	26.7	34.8	

220MM X 90MM SYSTEM

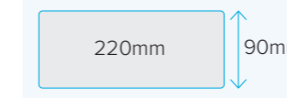

204MM X 60MM SYSTEM

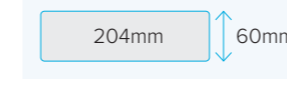

- 220x90mm
- 204x60mm

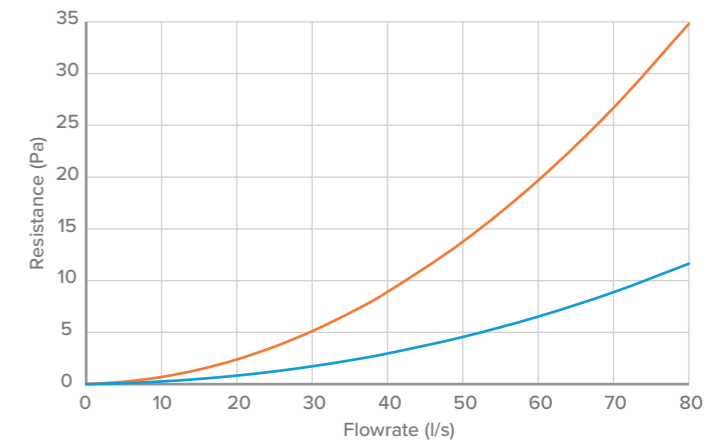

THERMAL 45° VERTICAL BEND

CODE	DUCT SIZE	DESCRIPTION	MATERIAL	COLOUR	FLAMMABILITY RATING	MANUFACTURED TO
NTD-220-45V	220mm x 90mm	Thermal 45° vertical bend	GPS (Graphite Polystyrene)	Grey	Class E to BS EN 13501-1	ISO9001
NTD-204-45V	204mm x 60mm	Thermal 45° vertical bend	GPS (Graphite Polystyrene)	Grey	Class E to BS EN 13501-1	ISO9001



PART NUMBER	DUCT SIZE	RESISTANCE IN Pa												
		5l/s	10l/s	15l/s	20l/s	25l/s	30l/s	35l/s	40l/s	50l/s	60l/s	70l/s	80l/s	
NTD-220-45V	220mm x 90mm	0.0	0.1	0.1	0.2	0.3	0.5	0.7	0.9	1.4	1.9	2.5	3.1	
NTD-204-45V	204mm x 60mm	0.1	0.2	0.4	0.6	0.9	1.2	1.6	2.1	3.2	4.5	6.1	8.0	

220MM X 90MM SYSTEM

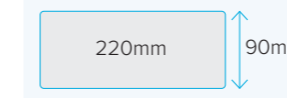

204MM X 60MM SYSTEM

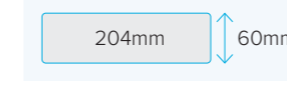

- 220x90mm
- 204x60mm

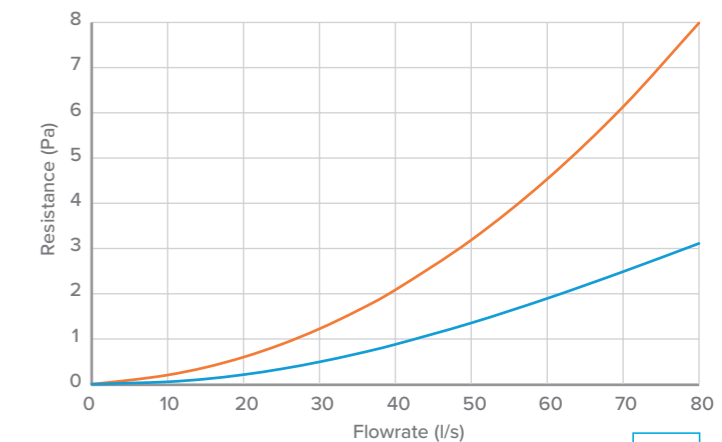



THERMAL PLENUM RECTANGULAR TO ROUND 220X90MM - Ø150MM

CODE	AIR DIRECTION		DESCRIPTION	MATERIAL	COLOUR	FLAMMABILITY RATING	MANUFACTURED TO
NTD-220-PL150	From	To	Thermal plenum, rectangular to round	GPS (Graphite Polystyrene)	Grey	Class E to BS EN 13501-1	ISO9001
	220mm x 90mm	Ø150mm					



PART NUMBER	AIR DIRECTION	RESISTANCE IN Pa											
		5l/s	10l/s	15l/s	20l/s	25l/s	30l/s	35l/s	40l/s	50l/s	60l/s	70l/s	80l/s
NTD-220-PL150	Intake (A) - Rect to Round	0.1	0.4	0.8	1.5	2.3	3.3	4.4	5.7	8.9	12.8	17.3	22.6
	Exhaust (A) - Round to Rect	0.2	0.7	1.5	2.6	4.1	5.8	7.8	10.2	15.8	22.7	30.9	40.4

220MM X 90MM SYSTEM

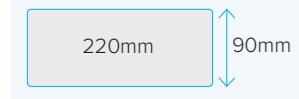

- 220x90mm - Rect to Round
- 220x90mm - Round to Rect

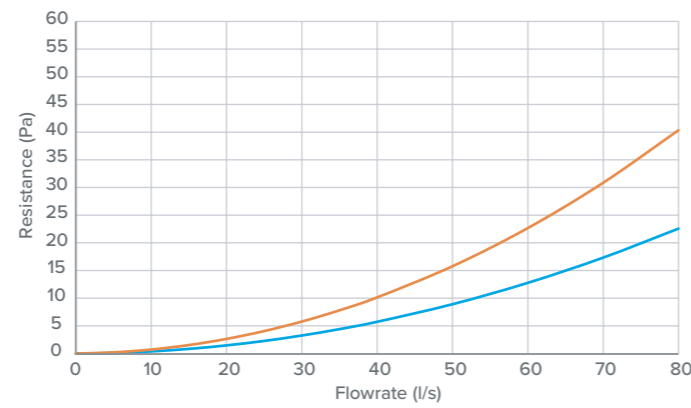

THERMAL PLENUM RECTANGULAR TO ROUND 204X60MM - Ø125MM

CODE	AIR DIRECTION		DESCRIPTION	MATERIAL	COLOUR	FLAMMABILITY RATING	MANUFACTURED TO
NTD-204-PL	From	To	Thermal plenum, rectangular to round	GPS (Graphite Polystyrene)	Grey	Class E to BS EN 13501-1	ISO9001
	204mm x 60mm	Ø125mm					

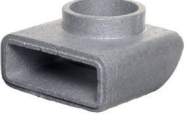

PART NUMBER	AIR DIRECTION	RESISTANCE IN Pa											
		5l/s	10l/s	15l/s	20l/s	25l/s	30l/s	35l/s	40l/s	50l/s	60l/s	70l/s	80l/s
NTD-204-PL	Rect to Round	0.1	0.6	1.6	3.0	4.8	6.9	9.3	12.0	18.	25.3	32.9	40.9
	Round to Rect	0.3	1.3	3.2	6.1	9.7	14.2	19.4	25.4	39.5	56.3	75.3	96.5

204MM X 60MM SYSTEM

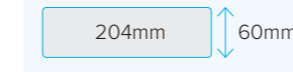

- 204x60mm Rect to Round
- 204x60mm Round to Rect

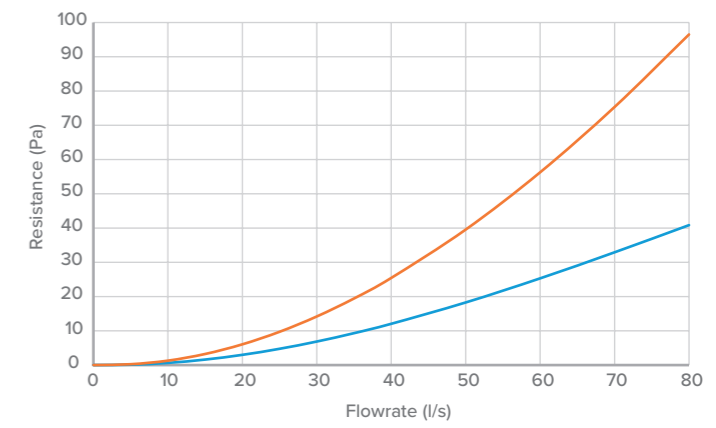

THERMAL PLENUM RECTANGULAR TO ROUND 220X90MM - Ø125MM

CODE	AIR DIRECTION		DESCRIPTION	MATERIAL	COLOUR	FLAMMABILITY RATING	MANUFACTURED TO
NTD-220-PL	From	To	Thermal plenum, rectangular to round	GPS (Graphite Polystyrene)	Grey	Class E to BS EN 13501-1	ISO9001
	220mm x 90mm	Ø125mm					

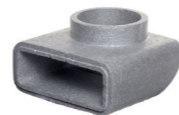

PART NUMBER	AIR DIRECTION	RESISTANCE IN Pa											
		5l/s	10l/s	15l/s	20l/s	25l/s	30l/s	35l/s	40l/s	50l/s	60l/s	70l/s	80l/s
NTD-220-PL	Rect to Round	0.2	0.8	1.8	3.2	5.1	7.3	9.9	12.9	20.1	28.9	39.3	51.3
	Round to Rect	0.3	1.0	2.3	4.1	6.3	9.1	12.4	16.1	25.0	35.6	48.0	61.9

220MM X 90MM SYSTEM

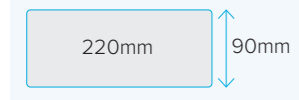

- 220x90mm Rect to Round
- 220x90mm Round to Rect

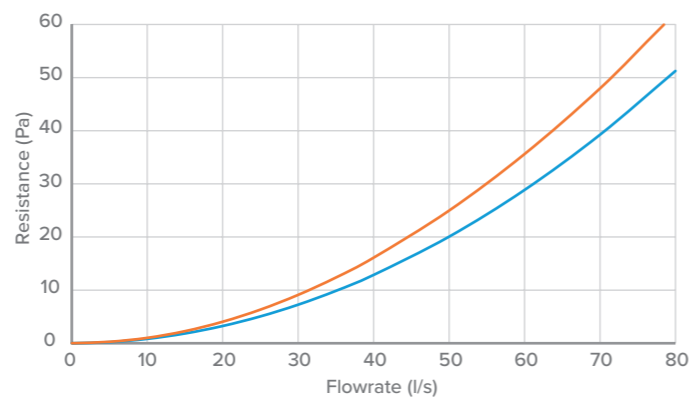

THERMAL IN-LINE ADAPTER RECTANGULAR TO ROUND 220X90MM - Ø150MM

CODE	DUCT SIZE		DESCRIPTION	MATERIAL	COLOUR	FLAMMABILITY RATING	MANUFACTURED TO
NTD-220-STR150	From	To	Thermal in-line adapter, rectangular to round	GPS (Graphite Polystyrene)	Grey	Class E to BS EN 13501-1	ISO9001
	220mm x 90mm	Ø150mm					



PART NUMBER	DUCT SIZE	RESISTANCE IN Pa							
		10l/s	20l/s	30l/s	40l/s	50l/s	60l/s	70l/s	80l/s
NTD-220-STR150	Rect to Round	0.1	0.3	0.6	1.1	1.7	2.4	3.4	4.5

220MM X 90MM SYSTEM

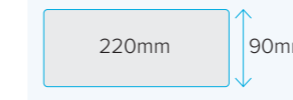

- 220x90mm Rect to Round

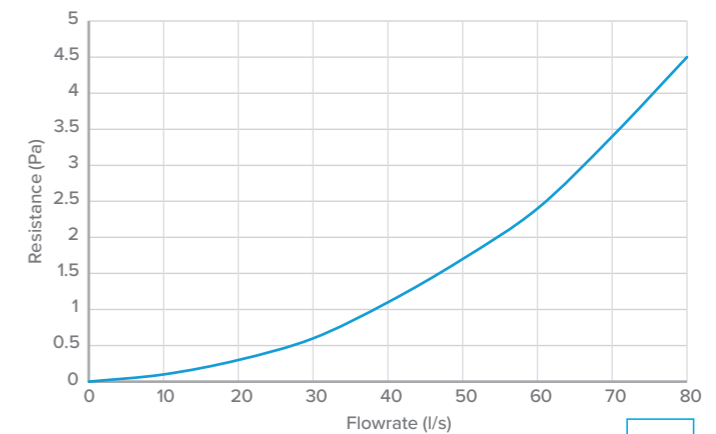

THERMAL IN-LINE ADAPTER RECTANGULAR TO ROUND 220X90MM - Ø125MM

CODE	DUCT SIZE		DESCRIPTION	MATERIAL	COLOUR	FLAMMABILITY RATING	MANUFACTURED TO
NTD-220-STR125	From	To	Thermal in-line adapter, rectangular to round	GPS (Graphite Polystyrene)	Grey	Class E to BS EN 13501-1	ISO9001
	220mm x 90mm	Ø125mm					



PART NUMBER	DUCT SIZE	To	RESISTANCE IN Pa							
			10l/s	20l/s	30l/s	40l/s	50l/s	60l/s	70l/s	80l/s
NTD-220-STR125	From	Ø125mm	0.2	0.9	2.0	3.5	5.4	7.6	10.2	13.1
	220mm x 90mm									

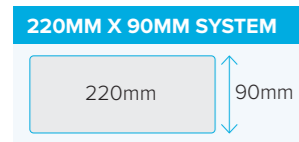

— 220x90mm

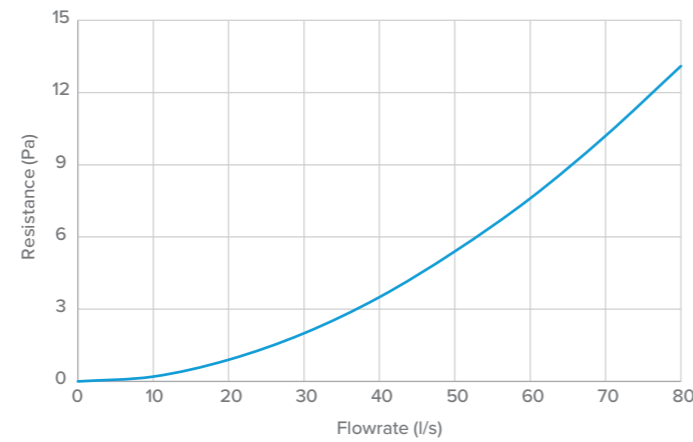

THERMAL DUCTING ONE PIECE CONNECTOR

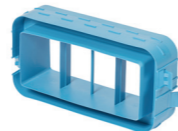
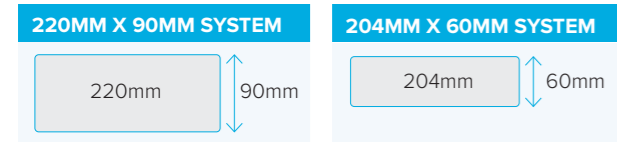

CODE	DUCT SIZE	DESCRIPTION	MATERIAL	COLOUR	FLAMMABILITY RATING	MANUFACTURED TO
NTD-220-OPC	220mm x 90mm	Thermal ducting one piece connector	Polypropylene	Blue	UL94-HB	ISO9001
NTD-204-OPC	204mm x 60mm	Thermal ducting one piece connector	Polypropylene	Blue	UL94-HB	ISO9001

THERMAL DUCTING BLACK INSERT

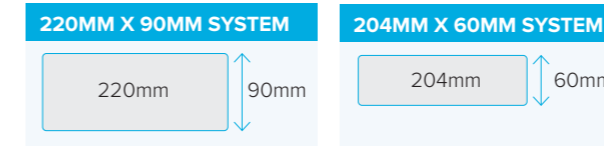

CODE	DUCT SIZE	DESCRIPTION	MATERIAL	COLOUR	FLAMMABILITY RATING	MANUFACTURED TO
NTD-220-INS	220mm x 90mm	Thermal ducting black insert	Polypropylene	Black	UL94-HB	ISO9001
NTD-204-INS	204mm x 60mm	Thermal ducting black insert	Polypropylene	Black	UL94-HB	ISO9001

THERMAL DUCTING CUTTING AID

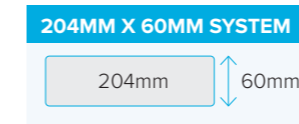

CODE	DUCT SIZE	DESCRIPTION
NTD-204-CUTTINGAID	204mm x 60mm	Cutting aid for thermal ducting



THERMAL REDUCER 220X90MM - 204X60MM

CODE	DUCT SIZE		DESCRIPTION	MATERIAL	COLOUR	FLAMMABILITY RATING	MANUFACTURED TO
NTD-220-RED204	From	To	Thermal in-line reducing piece	GPS (Graphite Polystyrene)	Grey	Class E to BS EN 13501-1	ISO9001
	220mm x 90mm	204mm x 60mm					

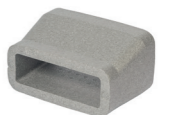

PART NUMBER	DUCT SIZE	To	RESISTANCE IN Pa							
			10l/s	20l/s	30l/s	40l/s	50l/s	60l/s	70l/s	80l/s
NTD-220-RED204	From	204mm x 60mm	0.4	1.5	3.3	5.7	8.8	12.6	17.1	22.2
	220mm x 90mm									

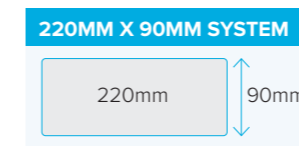

— 220x90mm

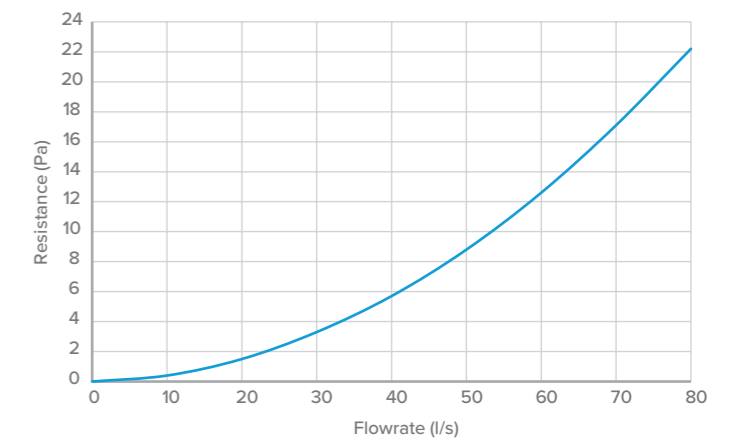

NUAIRE THERMAL DUCTMASTER CIRCULAR

THERMAL 1M LENGTH

CODE	DUCT SIZE	DESCRIPTION	MATERIAL	COLOUR	FLAMMABILITY RATING	MANUFACTURED TO
NTD-125-1M	Ø125mm	Thermal circular ducting length 1m	GPS (Graphite Polystyrene)	Grey	Class E to BS EN 13501-1	ISO9001



PART NUMBER	DUCT SIZE	RESISTANCE IN Pa												
		5l/s	10l/s	15l/s	20l/s	25l/s	30l/s	35l/s	40l/s	50l/s	60l/s	70l/s	80l/s	
NTD-125-1M	Ø125mm	0.0	0.1	0.3	0.4	0.6	0.8	1.1	1.4	2.0	2.6	3.3	3.9	

Ø125MM SYSTEM

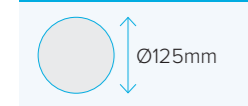

— Ø125mm

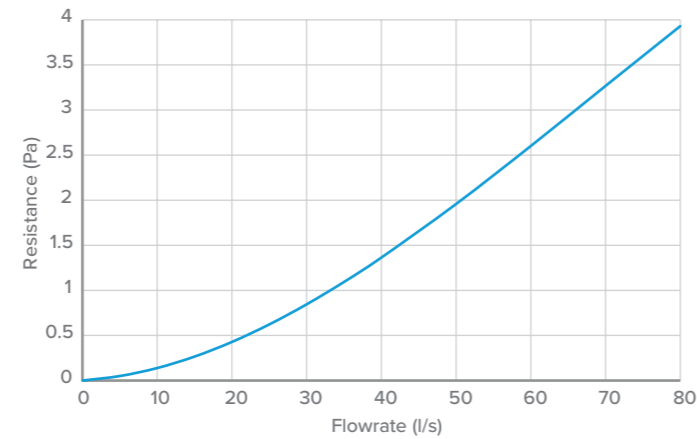

THERMAL T-PIECE

CODE	DUCT SIZE	DESCRIPTION	MATERIAL	COLOUR	FLAMMABILITY RATING	MANUFACTURED TO
NTD-125-TP	Ø125mm	Thermal circular T-piece	GPS (Graphite Polystyrene)	Grey	Class E to BS EN 13501-1	ISO9001



PART NUMBER	DUCT SIZE	RESISTANCE IN Pa												
		5l/s	10l/s	15l/s	20l/s	25l/s	30l/s	35l/s	40l/s	50l/s	60l/s	70l/s	80l/s	
NTD-125-TP	Ø125mm Equal T Piece A-B	0.0	0.1	0.6	1.4	2.3	3.6	5.0	6.6	10.5	15.3	20.7	27.0	
NTD-125-TP	Ø125mm Equal T Piece A-C	0.01	0.05	0.1	0.3	0.6	0.9	1.2	1.7	2.7	4.0	5.6	7.4	

Ø125MM SYSTEM

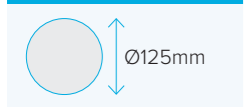

— Ø125mm Equal T Piece A-B
— Ø125mm Equal T Piece A-C

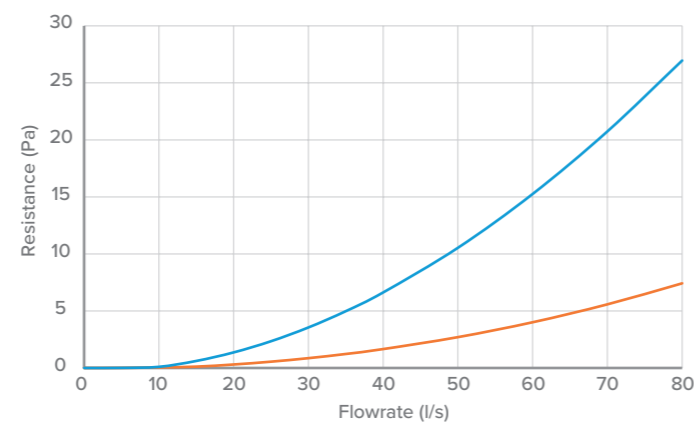
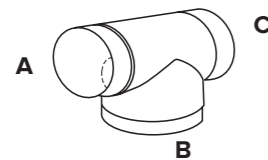

THERMAL 90° CIRCULAR BEND

CODE	DUCT SIZE	DESCRIPTION	MATERIAL	COLOUR	FLAMMABILITY RATING	MANUFACTURED TO
NTD-125-90H	Ø125mm	Thermal 90° circular bend	GPS (Graphite Polystyrene)	Grey	Class E to BS EN 13501-1	ISO9001



PART NUMBER	DUCT SIZE	RESISTANCE IN Pa												
		5l/s	10l/s	15l/s	20l/s	25l/s	30l/s	35l/s	40l/s	50l/s	60l/s	70l/s	80l/s	
NTD-125-90H	Ø125mm	0.1	0.4	1.0	1.8	2.9	4.2	5.7	7.3	11.3	15.8	20.9	26.4	

Ø125MM SYSTEM

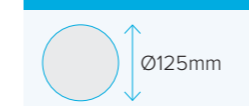

— Ø125mm

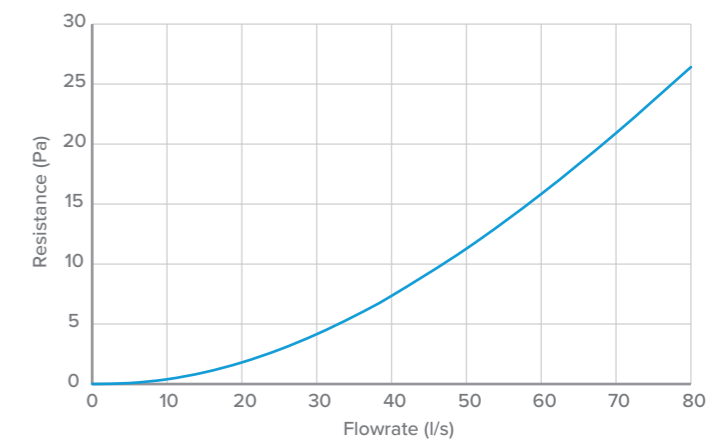

THERMAL 45° CIRCULAR BEND

CODE	DUCT SIZE	DESCRIPTION	MATERIAL	COLOUR	FLAMMABILITY RATING	MANUFACTURED TO
NTD-125-45H	Ø125mm	Thermal 45° circular bend	GPS (Graphite Polystyrene)	Grey	Class E to BS EN 13501-1	ISO9001



PART NUMBER	DUCT SIZE	RESISTANCE IN Pa												
		5l/s	10l/s	15l/s	20l/s	25l/s	30l/s	35l/s	40l/s	50l/s	60l/s	70l/s	80l/s	
NTD-125-45H	Ø125mm	0.0	0.1	0.3	0.5	0.7	1.0	1.4	1.9	3.0	4.4	6.1	8.3	

Ø125MM SYSTEM

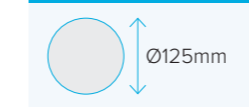

— Ø125mm

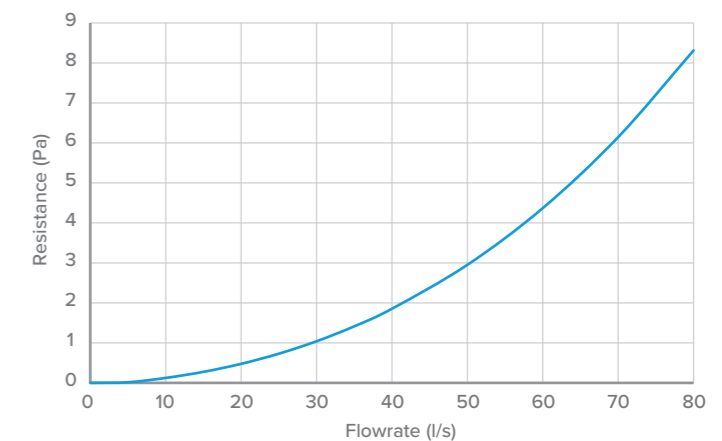

THERMAL DUCTING CONDENSATION TRAP

CODE	DUCT SIZE	DESCRIPTION	MATERIAL	COLOUR	FLAMMABILITY RATING	MANUFACTURED TO
NTD-125-CONTRAP	Ø125mm	Thermal ducting condensation trap	GPS (Graphite Polystyrene)	Grey	Class E to BS EN 13501-1	ISO9001

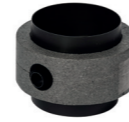

PART NUMBER	DUCT SIZE	RESISTANCE IN Pa								
		10l/s	20l/s	30l/s	40l/s	50l/s	60l/s	70l/s	80l/s	
NTD-125-CONTRAP	Ø125mm	0.5	2.6	6.4	11.9	19.1	28.0	38.5	50.8	

Ø125MM SYSTEM

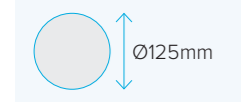

— Ø125mm

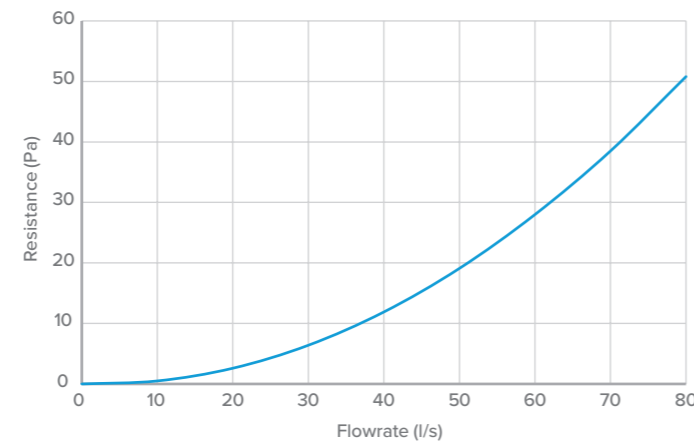

THERMAL DUCTING ONE PIECE CONNECTOR

Ø125MM SYSTEM	CODE	DUCT SIZE	DESCRIPTION	MATERIAL	COLOUR	FLAMMABILITY RATING	MANUFACTURED TO
	NTD-125-OPC	Ø125mm	Thermal ducting one piece connector	Polypropylene	Blue	UL94-HB	ISO9001



THERMAL DUCTING BLACK INSERT

Ø125MM SYSTEM	CODE	DUCT SIZE	DESCRIPTION	MATERIAL	COLOUR	FLAMMABILITY RATING	MANUFACTURED TO
	NTD-125-INS	Ø125mm	Thermal ducting black insert	Polypropylene	Black	UL94-HB	ISO9001



THERMAL DUCTING CUTTING AID

Ø125MM SYSTEM	CODE	DUCT SIZE	DESCRIPTION
	NTD-125-CUTTINGAID	Ø125mm	Cutting aid for thermal ducting

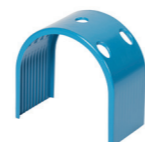

DUCTMASTER RIGID

DESCRIPTION

A range of ducting and ancillaries intended for installation in domestic properties. Available in six different profiles to suit any application.

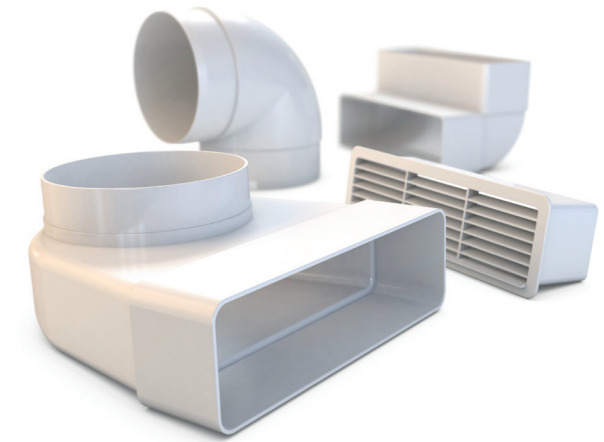

MATERIALS

- High Impact Polystyrene (HIPS)
- Extruded Unplasticized Polyvinyl Chloride (uPVC)
- Polyvinyl Chloride (PVC)
- Polystyrene (PS)
- Acrylonitrile Butadiene Styrene (ABS)

FLAMMABILITY

- UL94-HB/V0 to BS EN 60695-11-10 Fire hazard testing
- Test flames 50 W horizontal and vertical flame test methods.

ASSEMBLY AND FITTING INSTRUCTIONS

In order to provide maximum circulation of air in each room intended to be ventilated, position individual Nuair Ventilation air valves diagonally opposite the door into the room or as near to this position as building construction limitations allow. **Note: It is recommended that internal doors have a 10mm air gap at the bottom to allow the transfer of air flow whilst the door is shut.**

The Nuair Ventilation duct system that connects all of the extract air valves together should ideally form the shape of a stylised 'tree'. This should consist of a central 'trunk' (duct), connected to the appliance, with the air valves positioned at the end of each individual duct 'branch' to provide an approximate balanced air flow. The final air flow will be balanced by adjusting the individual air valves.

IMPORTANT NOTICE

To ensure optimum performance is achieved by the appliance and to avoid damage from condensate leakage, Nuair Ventilation recommends all duct joints must be 100% sealed with Nuair Ventilation PVCDSEAL acrylic duct sealant, or DDSEAL (fire resistant). Please refer to Part F for regulatory standards required.

Nuair Ventilation ducting should be supported using good quality proprietary duct support systems or products such as PVCSEAL galvanised banding.

Care must be taken to ensure that the ducting or insulation is not damaged or pierced. It is recommended that the ducting is supported at least every 1.0m and either side of any joint to provide extra mechanical strength.

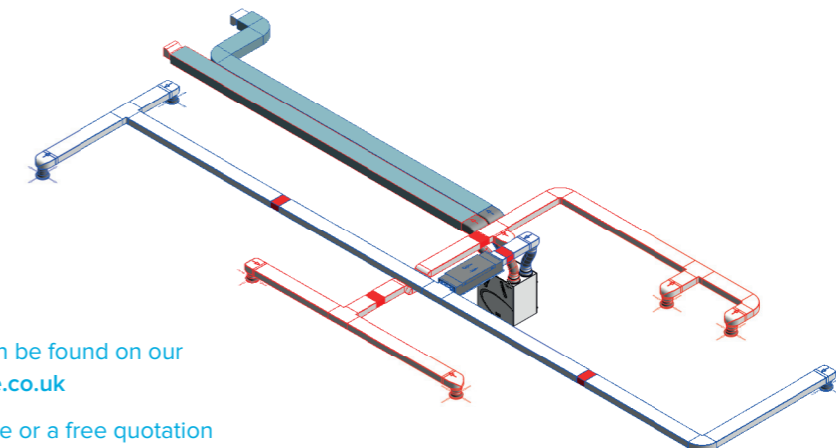

Full product ranges can be found on our website at www.nuair.co.uk

For technical assistance or a free quotation and design, please call **029 2085 8500** or email residentialenquiries@nuair.co.uk

DUCTMASTER RIGID RECTANGULAR

2M RECTANGULAR DUCT LENGTH

220MM X 90MM SYSTEM	204MM X 60MM SYSTEM	110MM X 54MM SYSTEM



CODE	DUCT SIZE	DESCRIPTION	CONNECTION	MATERIAL	COLOUR	FLAMMABILITY RATING	MANUFACTURED TO
D4-2000	220mm x 90mm	2m straight length of ducting	Duct	Extruded uPVC	White	UL94V0	ISO9001
D3-2000	204mm x 60mm	2m straight length of ducting	Duct	Extruded uPVC	White	UL94V0	ISO9001
D1-2000	110mm x 54mm	2m straight length of ducting	Duct	Extruded uPVC	White	UL94V0	ISO9001

PART NUMBER	DUCT SIZE	RESISTANCE IN Pa											
		5l/s	10l/s	15l/s	20l/s	25l/s	30l/s	35l/s	40l/s	50l/s	60l/s	70l/s	80l/s
D4-2000	220mm x 90mm	0.0	0.1	0.2	0.3	0.5	0.7	0.9	1.1	1.7	2.4	3.1	3.9
D3-2000	204mm x 60mm	0.2	0.6	1.1	1.7	2.4	3.2	4.1	5.1	7.4	9.9	12.6	15.5

220MM X 90MM SYSTEM
204MM X 60MM SYSTEM

— 220x90mm
— 204x60mm

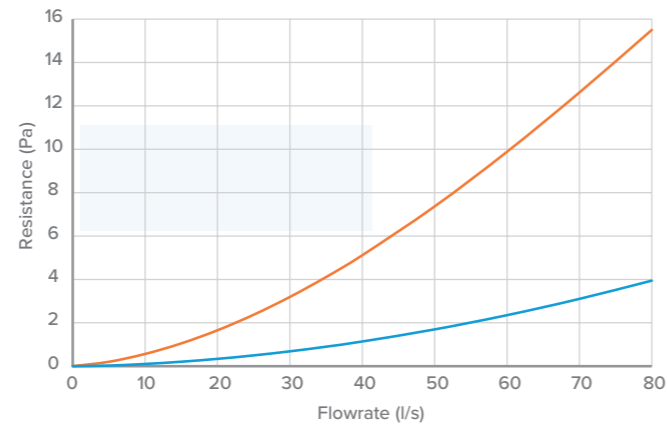

PART NUMBER	DUCT SIZE	RESISTANCE IN Pa							
		5l/s	10l/s	15l/s	20l/s	25l/s	30l/s	35l/s	40l/s
D1-2000	110mm x 54mm	0.6	2.0	4.3	7.5	11.3	15.9	21.2	27.1

110MM X 54MM SYSTEM

— 110x54mm

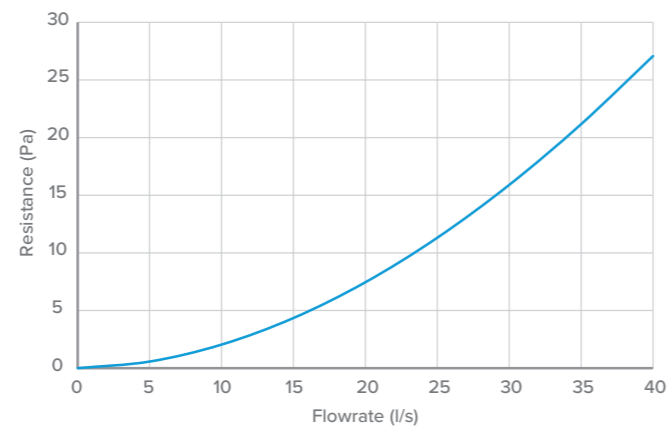

1.5M RECTANGULAR DUCT LENGTH

220MM X 90MM SYSTEM	204MM X 60MM SYSTEM	121MM X 60MM SYSTEM	110MM X 54MM SYSTEM



CODE	DUCT SIZE	DESCRIPTION	CONNECTION	MATERIAL	COLOUR	FLAMMABILITY RATING	MANUFACTURED TO
PVC915WH	220mm x 90mm	1.5m straight length of ducting	Duct	Extruded uPVC	White	UL94V0	ISO9001
PVC515WH	204mm x 60mm	1.5m straight length of ducting	Duct	Extruded uPVC	White	UL94V0	ISO9001
PVC4015WH	121mm x 60mm	1.5m straight length of ducting	Duct	Extruded uPVC	White	UL94V0	ISO9001
PVC015WH	110mm x 54mm	1.5m straight length of ducting	Duct	Extruded uPVC	White	UL94V0	ISO9001

PART NUMBER	DUCT SIZE	RESISTANCE IN Pa															
		5l/s	10l/s	15l/s	20l/s	25l/s	30l/s	35l/s	40l/s	50l/s	60l/s	70l/s	80l/s				
PVC915WH	220mm x 90mm	0.0	0.1	0.2	0.3	0.4	0.5	0.7	0.9	1.3	1.8	2.3	3.0				
PVC515WH	204mm x 60mm	0.2	0.4	0.8	1.2	1.8	2.4	3.1	3.8	5.5	7.4	9.5	11.6				

220MM X 90MM SYSTEM
204MM X 60MM SYSTEM

— 220x90mm
— 204x60mm

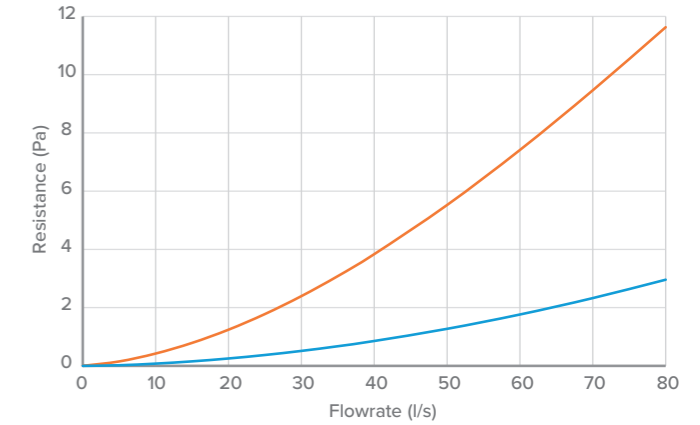

PART NUMBER	DUCT SIZE	RESISTANCE IN Pa							
		5l/s	10l/s	15l/s	20l/s	25l/s	30l/s	35l/s	40l/s
PVC4015WH	121mm x 60mm	0.4	1.0	1.8	2.9	4.1	5.5	7.1	9.0
PVC015WH	110mm x 54mm	0.4	1.5	3.3	5.6	8.5	11.9	15.9	20.3

121MM X 60MM SYSTEM
110MM X 54MM SYSTEM

— 121x60mm
— 110x54mm

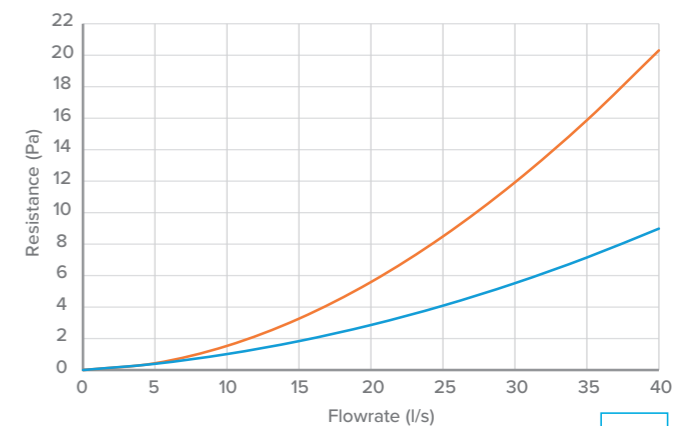

1M RECTANGULAR DUCT LENGTH

220MM X 90MM SYSTEM	204MM X 60MM SYSTEM	121MM X 60MM SYSTEM	110MM X 54MM SYSTEM



CODE	DUCT SIZE	DESCRIPTION	CONNECTION	MATERIAL	COLOUR	FLAMMABILITY RATING	MANUFACTURED TO
PVC910WH	220mm x 90mm	1.0m straight length of ducting	Duct	Extruded uPVC	White	UL94V0	ISO9001
PVC510WH	204mm x 60mm	1.0m straight length of ducting	Duct	Extruded uPVC	White	UL94V0	ISO9001
PVC4010WH	121mm x 60mm	1.0m straight length of ducting	Duct	Extruded uPVC	White	UL94V0	ISO9001
PVC010WH	110mm x 54mm	1.0m straight length of ducting	Duct	Extruded uPVC	White	UL94V0	ISO9001

RECTANGULAR DUCT CONNECTOR

220MM X 90MM SYSTEM	204MM X 60MM SYSTEM	121MM X 60MM SYSTEM	110MM X 54MM SYSTEM



CODE	DUCT SIZE	DESCRIPTION	CONNECTION	MATERIAL	COLOUR	FLAMMABILITY RATING	MANUFACTURED TO
PVC920WH	220mm x 90mm	Rectangular duct connector	Female	HIPS (High Impact Polystyrene)	White	UL94HB	ISO9001
PVC520WH	204mm x 60mm	Rectangular duct connector	Female	HIPS (High Impact Polystyrene)	White	UL94HB	ISO9001
PVC420WH	121mm x 60mm	Rectangular duct connector	Female	HIPS (High Impact Polystyrene)	White	UL94HB	ISO9001
PVC020WH	110mm x 54mm	Rectangular duct connector	Female	HIPS (High Impact Polystyrene)	White	UL94HB	ISO9001

PART NUMBER	DUCT SIZE	RESISTANCE IN Pa												
		5l/s	10l/s	15l/s	20l/s	25l/s	30l/s	35l/s	40l/s	50l/s	60l/s	70l/s	80l/s	
PVC910WH	220mm x 90mm	0.0	0.1	0.1	0.2	0.2	0.3	0.4	0.6	0.8	1.2	1.6	2.0	
PVC510WH	204mm x 60mm	0.1	0.3	0.5	0.8	1.2	1.6	2.1	2.6	3.7	4.9	6.3	7.8	

220MM X 90MM SYSTEM

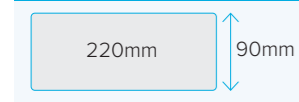

204MM X 60MM SYSTEM

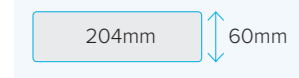

— 220x90mm
— 204x60mm

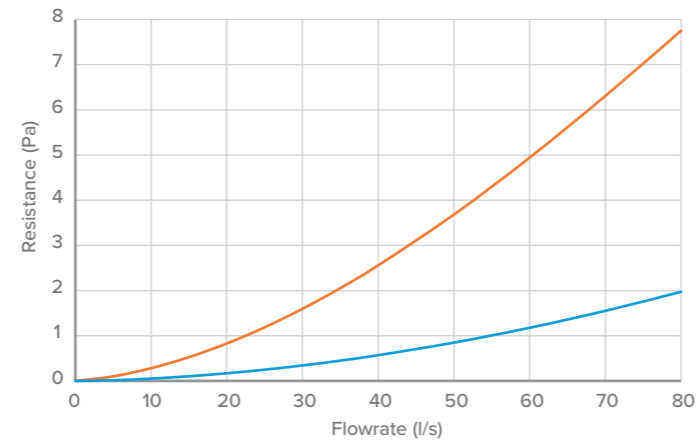

PART NUMBER	DUCT SIZE	RESISTANCE IN Pa								
		5l/s	10l/s	15l/s	20l/s	25l/s	30l/s	35l/s	40l/s	
PVC4010WH	121 x 60mm	0.3	0.7	1.2	1.9	2.7	3.7	4.8	6.0	
PVC010WH	110mm x 54mm	0.3	1.0	2.2	3.7	5.7	7.9	10.6	13.5	

121MM X 60MM SYSTEM

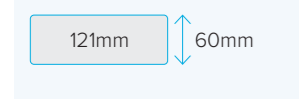

110MM X 54MM SYSTEM

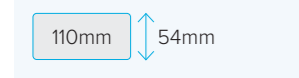

— 121x60mm
— 110x54mm

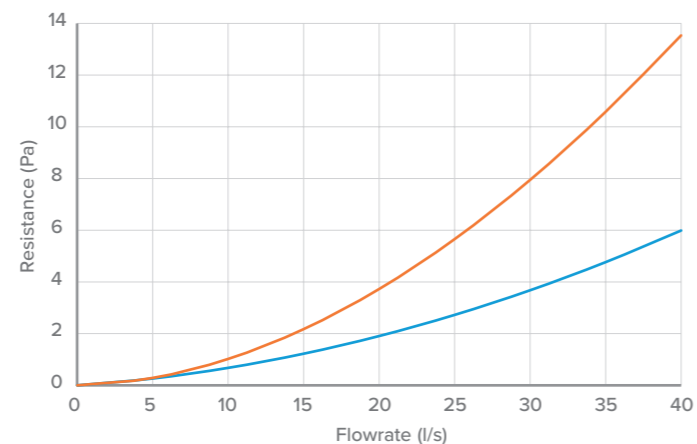

RECTANGULAR DUCT CLIP

- Duct clips are an effective part of the overall duct system and quickly fasten into place.
- Duct clips securely hold duct runs and prevent them from bobbing.

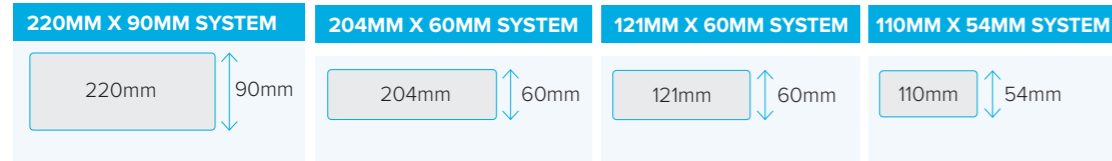

CODE	DUCT SIZE	DESCRIPTION	MATERIAL	COLOUR
PVC922WH	220mm x 90mm	2 x Z-shape rectangular channel clips	HIPS (High Impact Polystyrene)	White
PVC122-5WH	204mm x 60mm	2 x Z-shape rectangular channel clips	HIPS (High Impact Polystyrene)	White
PVC422WH	121mm x 60mm	Complete rectangular channel clip	HIPS (High Impact Polystyrene)	White
PVC122WH	110mm x 54mm	1x U-shape rectangular channel clip	HIPS (High Impact Polystyrene)	White

CODE	DUCT SIZE	DESCRIPTION	MATERIAL	COLOUR
PVC422WH-V	121mm x 60mm	One half rectangular channel clip*	HIPS (High Impact Polystyrene)	White
PVC122WH-V	110mm x 54mm	One half rectangular channel clip*	HIPS (High Impact Polystyrene)	White

*Two components per fitting required



90° HORIZONTAL BEND

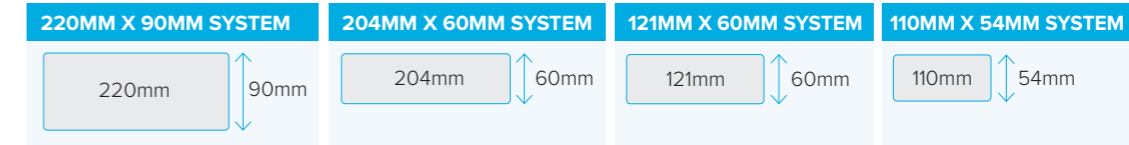

CODE	DUCT SIZE	DESCRIPTION	CONNECTION	MATERIAL	COLOUR	FLAMMABILITY RATING	MANUFACTURED TO
PVC950WH	220mm x 90mm	90° horizontal bend	Female	HIPS (High Impact Polystyrene)	White	UL94HB	ISO9001
PVC550WH	204mm x 60mm	90° horizontal bend	Female	HIPS (High Impact Polystyrene)	White	UL94HB	ISO9001
PVC450WH	121mm x 60mm	90° horizontal bend	Female	HIPS (High Impact Polystyrene)	White	UL94HB	ISO9001
PVC050WH	110mm x 54mm	90° horizontal bend	Female	HIPS (High Impact Polystyrene)	White	UL94HB	ISO9001

PART NUMBER	DUCT SIZE	RESISTANCE IN Pa											
		5l/s	10l/s	15l/s	20l/s	25l/s	30l/s	35l/s	40l/s	50l/s	60l/s	70l/s	80l/s
PVC950WH	220mm x 90mm	0.1	0.3	0.6	1.0	1.5	2.1	2.8	3.6	5.5	7.8	10.6	13.7
PVC550WH	204mm x 60mm	0.3	0.9	1.7	2.9	4.4	6.3	8.4	10.9	16.8	24.0	32.7	42.7

220MM X 90MM SYSTEM

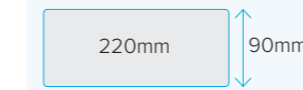

204MM X 60MM SYSTEM

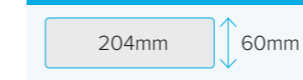

- 220x90mm
- 204x60mm

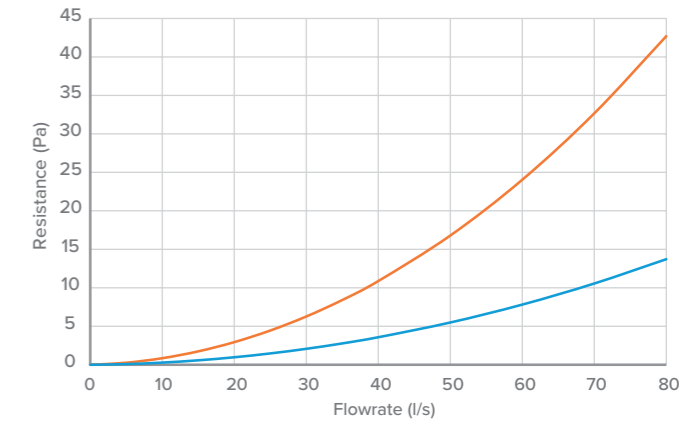

PART NUMBER	DUCT SIZE	RESISTANCE IN Pa							
		5l/s	10l/s	15l/s	20l/s	25l/s	30l/s	35l/s	40l/s
PVC450WH	121mm x 60mm	0.8	2.9	6.3	11.2	17.4	24.9	33.8	44.1
PVC050WH	110mm x 54mm	0.7	2.4	5.0	8.7	13.4	19.3	26.2	34.5

121MM X 60MM SYSTEM

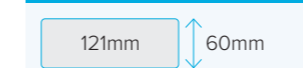

110MM X 54MM SYSTEM

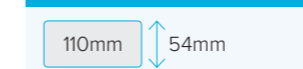

- 121x60mm
- 110x54mm

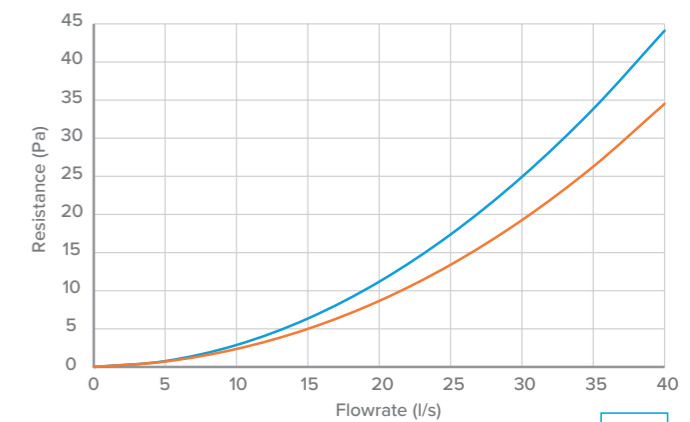

90° VERTICAL BEND

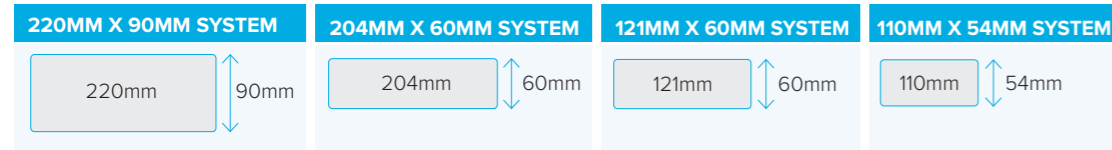

CODE	DUCT SIZE	DESCRIPTION	CONNECTION	MATERIAL	COLOUR	FLAMMABILITY RATING	MANUFACTURED TO
PVC960WH	220mm x 90mm	90° vertical bend	Female	HIPS (High Impact Polystyrene)	White	UL94HB	ISO9001
PVC560WH	204mm x 60mm	90° vertical bend	Female	HIPS (High Impact Polystyrene)	White	UL94HB	ISO9001
PVC460WH	121mm x 60mm	90° vertical bend	Female	HIPS (High Impact Polystyrene)	White	UL94HB	ISO9001
PVC060WH	110mm x 54mm	90° vertical bend	Female	HIPS (High Impact Polystyrene)	White	UL94HB	ISO9001

PART NUMBER	DUCT SIZE	RESISTANCE IN Pa											
		5l/s	10l/s	15l/s	20l/s	25l/s	30l/s	35l/s	40l/s	50l/s	60l/s	70l/s	80l/s
PVC960WH	220mm x 90mm	0.1	0.3	0.5	0.8	1.2	1.7	2.3	3.0	4.6	6.5	8.9	11.6
PVC560WH	204mm x 60mm	0.2	0.7	1.4	2.4	3.6	5.1	6.9	8.9	13.8	19.7	26.7	34.8

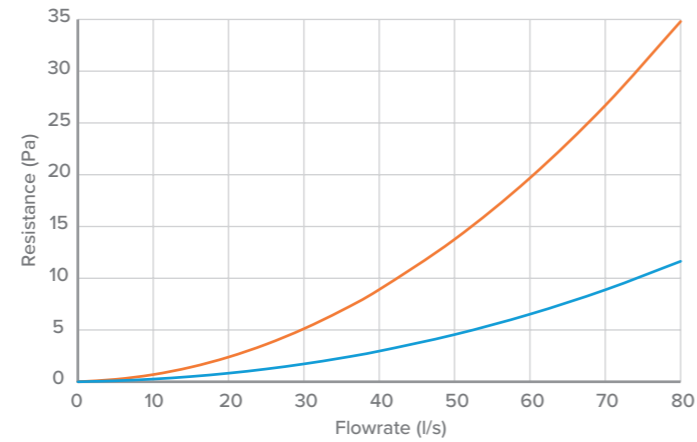
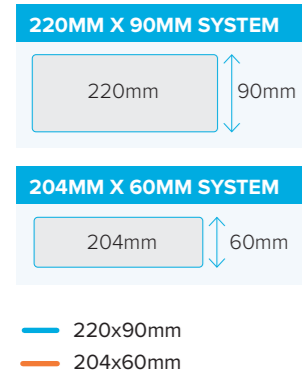

PART NUMBER	DUCT SIZE	RESISTANCE IN Pa							
		5l/s	10l/s	15l/s	20l/s	25l/s	30l/s	35l/s	40l/s
PVC460WH	121mm x 60mm	0.8	3.4	7.6	13.4	20.9	30.1	40.9	53.4
PVC060WH	110mm x 54mm	0.7	2.7	5.9	10.3	15.9	22.8	30.9	40.3

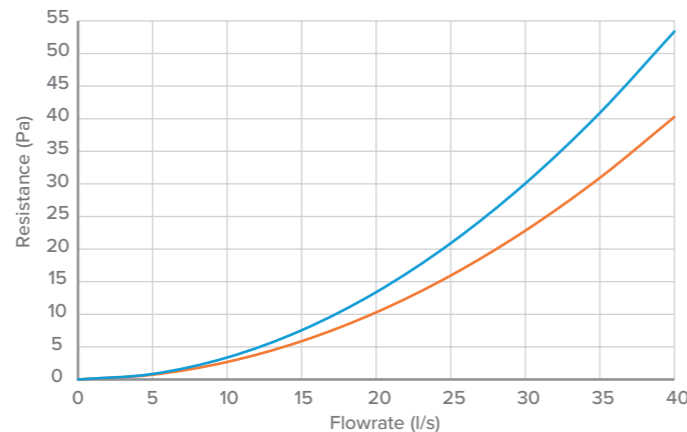
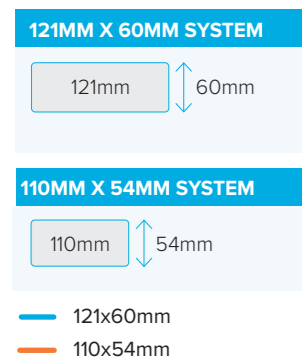

90° HORIZONTAL GREEN LINE BEND

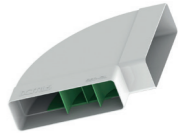
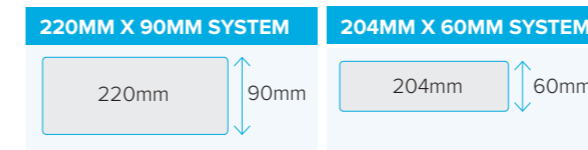

CODE	DUCT SIZE	DESCRIPTION	CONNECTION	MATERIAL	COLOUR	FLAMMABILITY RATING	MANUFACTURED TO
PVC950WH-GL	220mm x 90mm	90° horizontal high efficiency green line bend	Female	Injection Moulded HIPS (High Impact Polystyrene)	White	UL94HB	ISO9001
PVC550WH-GL	204mm x 60mm	90° horizontal high efficiency green line bend	Female	Injection Moulded HIPS (High Impact Polystyrene)	White	UL94HB	ISO9001

PART NUMBER	DUCT SIZE	RESISTANCE IN Pa											
		5l/s	10l/s	15l/s	20l/s	25l/s	30l/s	35l/s	40l/s	50l/s	60l/s	70l/s	80l/s
PVC950WH-GL	220mm x 90mm	0.1	0.1	0.3	0.5	0.7	1.0	1.3	1.6	2.4	3.4	4.5	5.7
PVC550WH-GL	204mm x 60mm	0.2	0.5	1.0	1.6	2.4	3.3	4.3	5.4	7.8	10.4	13.2	16.1

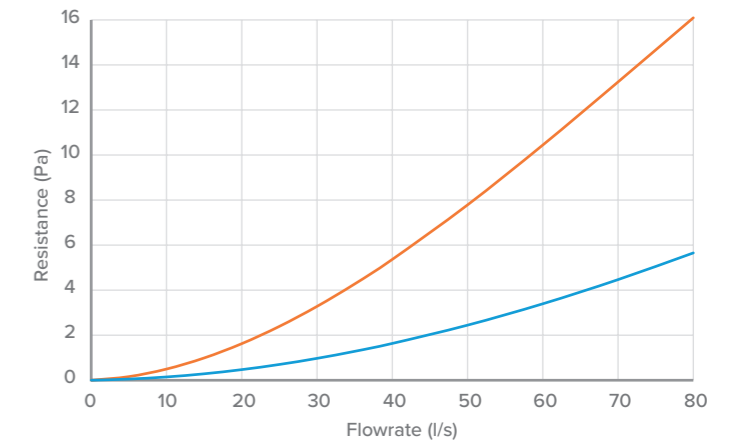
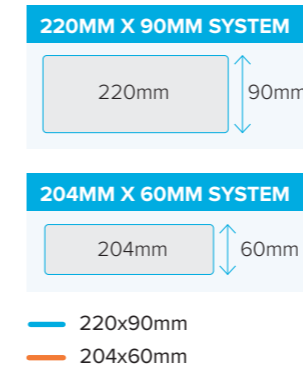

45° HORIZONTAL BEND



CODE	DUCT SIZE	DESCRIPTION	CONNECTION	MATERIAL	COLOUR	FLAMMABILITY RATING	MANUFACTURED TO
PVC955WH	220mm x 90mm	45° horizontal bend	Female	HIPS (High Impact Polystyrene)	White	UL94HB	ISO9001
PVC555WH	204mm x 60mm	45° horizontal bend	Female	HIPS (High Impact Polystyrene)	White	UL94HB	ISO9001
PVC055WH	110mm x 54mm	45° horizontal bend	Female	HIPS (High Impact Polystyrene)	White	UL94HB	ISO9001

PART NUMBER	DUCT SIZE	RESISTANCE IN Pa											
		5l/s	10l/s	15l/s	20l/s	25l/s	30l/s	35l/s	40l/s	50l/s	60l/s	70l/s	80l/s
PVC955WH	220mm x 90mm	0.0	0.1	0.2	0.3	0.4	0.6	0.8	1.0	1.6	2.4	3.3	4.4
PVC555WH	204mm x 60mm	0.1	0.2	0.5	0.9	1.3	1.9	2.5	3.2	5.0	7.2	9.8	12.8

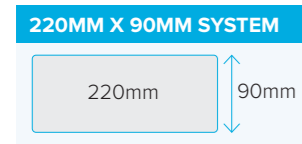

— 220x90mm
— 204x60mm

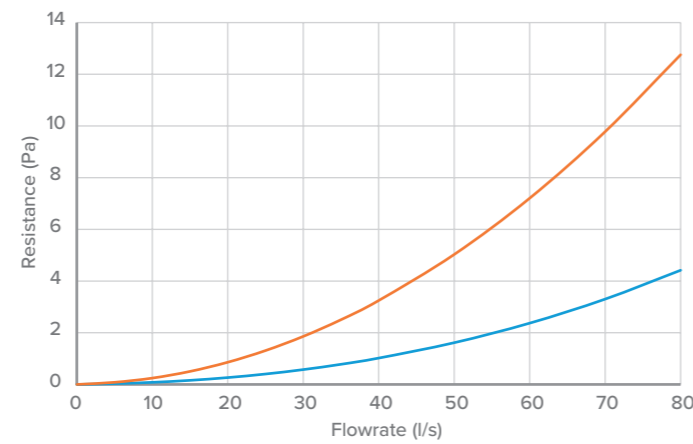

PART NUMBER	DUCT SIZE	RESISTANCE IN Pa							
		5l/s	10l/s	15l/s	20l/s	25l/s	30l/s	35l/s	40l/s
PVC055WH	110mm x 54mm	0.2	0.8	1.7	2.9	4.5	6.5	8.9	11.6

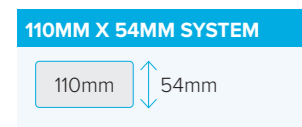

— 110x54mm

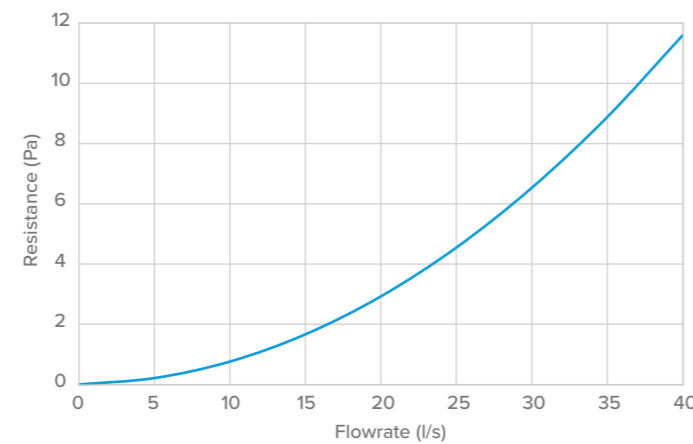

45° VERTICAL BEND



CODE	DUCT SIZE	DESCRIPTION	CONNECTION	MATERIAL	COLOUR	FLAMMABILITY RATING	MANUFACTURED TO
PVC975WH	220mm x 90mm	45° vertical bend	Female	HIPS (High Impact Polystyrene)	White	UL94HB	ISO9001
PVC575WH	204mm x 60mm	45° vertical bend	Female	HIPS (High Impact Polystyrene)	White	UL94HB	ISO9001
PVC075WH	110mm x 54mm	45° vertical bend	Female	HIPS (High Impact Polystyrene)	White	UL94HB	ISO9001

PART NUMBER	DUCT SIZE	RESISTANCE IN Pa											
		5l/s	10l/s	15l/s	20l/s	25l/s	30l/s	35l/s	40l/s	50l/s	60l/s	70l/s	80l/s
PVC975WH	220mm x 90mm	0.0	0.1	0.1	0.2	0.3	0.5	0.7	0.9	1.4	1.9	2.5	3.1
PVC575WH	204mm x 60mm	0.1	0.2	0.4	0.6	0.9	1.2	1.6	2.1	3.2	4.5	6.1	8.0

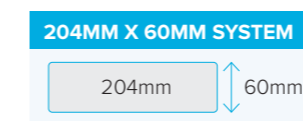
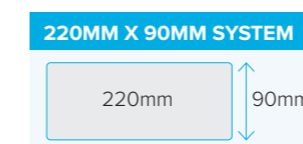

— 220x90mm
— 204x60mm

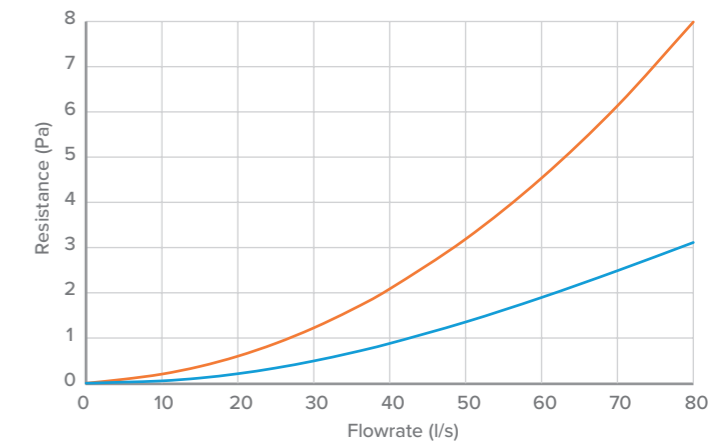

PART NUMBER	DUCT SIZE	RESISTANCE IN Pa							
		5l/s	10l/s	15l/s	20l/s	25l/s	30l/s	35l/s	40l/s
PVC075WH	110mm x 54mm	0.2	0.6	1.3	2.3	3.5	5.1	7.0	9.3

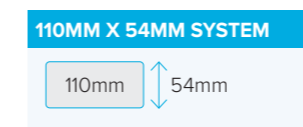

— 110x54mm

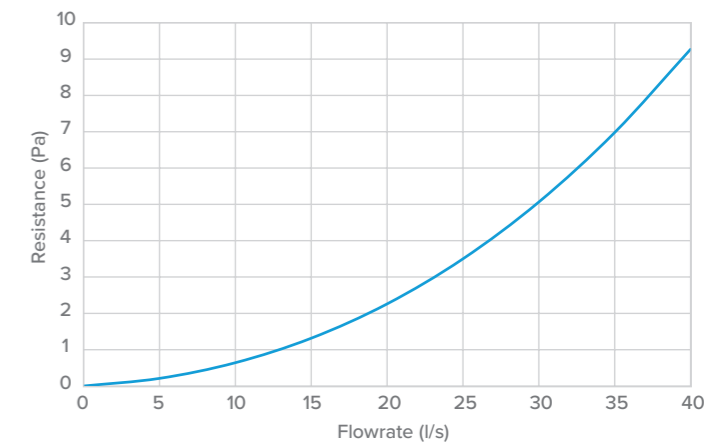

HORIZONTAL T-PIECE

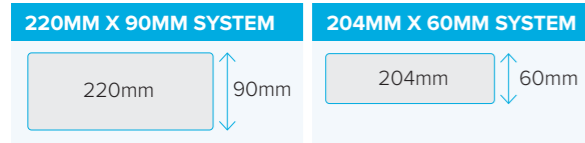

CODE	DUCT SIZE	DESCRIPTION	CONNECTION	MATERIAL	COLOUR	FLAMMABILITY RATING	MANUFACTURED TO
PVC982WH	220mm x 90mm	Horizontal T-Piece	Female	HIPS (High Impact Polystyrene)	White	UL94HB	ISO9001
PVC582WH	204mm x 60mm	Horizontal T-Piece	Female	HIPS (High Impact Polystyrene)	White	UL94HB	ISO9001
PVC080WH	110mm x 54mm	Horizontal T-Piece	Female	HIPS (High Impact Polystyrene)	White	UL94HB	ISO9001

PART NUMBER	DUCT SIZE	RESISTANCE IN Pa												
		5l/s	10l/s	15l/s	20l/s	25l/s	30l/s	35l/s	40l/s	50l/s	60l/s	70l/s	80l/s	
PVC982WH	220mm x 90mm Equal T Piece A-B	0.0	0.2	0.6	1.1	1.8	2.6	3.6	4.7	7.3	10.4	14.1	18.1	
PVC982WH	220mm x 90mm Equal T Piece A-C	0.1	0.2	0.4	0.6	0.8	1.2	1.6	2.0	3.0	4.2	5.6	7.1	

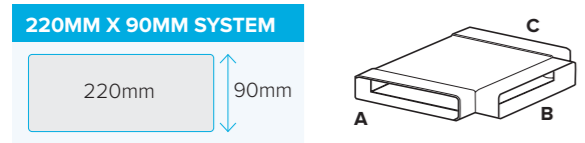

- 220x90mm Equal T Piece A-B
- 220x90mm Equal T Piece A-C

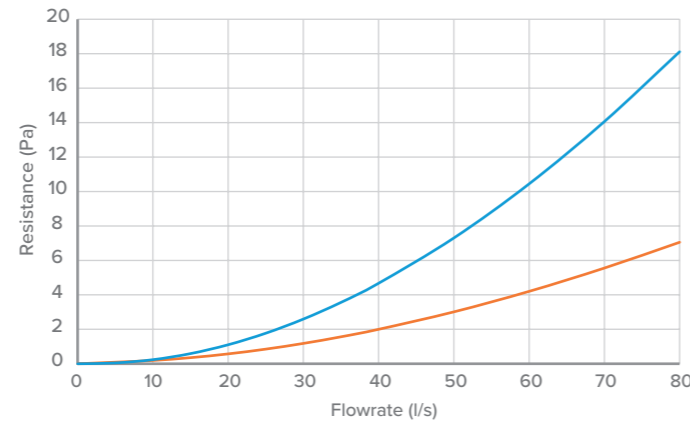

PART NUMBER	DUCT SIZE	RESISTANCE IN Pa												
		5l/s	10l/s	15l/s	20l/s	25l/s	30l/s	35l/s	40l/s	50l/s	60l/s	70l/s	80l/s	
PVC582WH	204mm x 60mm Equal T Piece A-B	0.1	0.3	1.1	2.1	3.5	5.3	7.3	9.7	15.4	22.3	30.4	39.6	
PVC582WH	204mm x 60mm Equal T Piece A-C	0.0	0.1	0.3	0.6	1.1	1.7	2.4	3.2	5.2	7.7	10.6	13.9	

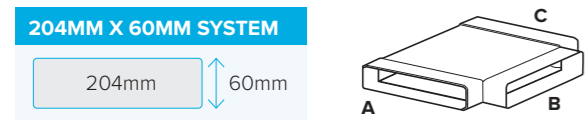

- 204x60mm Equal T Piece A-B
- 204x60mm Equal T Piece A-C

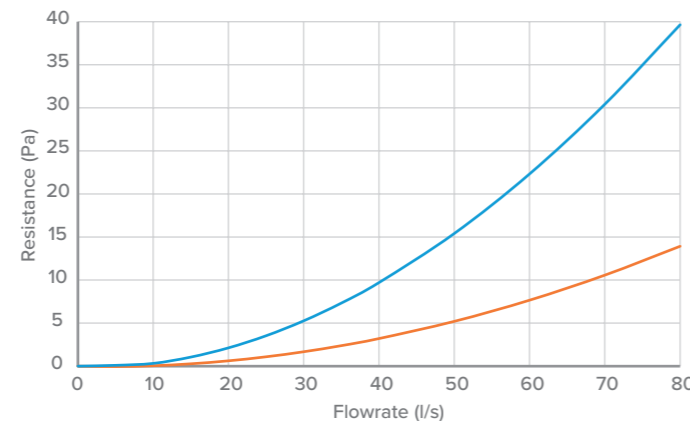

PART NUMBER	DUCT SIZE	RESISTANCE IN Pa												
		5l/s	10l/s	15l/s	20l/s	25l/s	30l/s	35l/s	40l/s	50l/s	60l/s	70l/s	80l/s	
PVC080WH	110mm x 54mm Equal T Piece A-B	0.5	2.2	5.2	9.5	15.0	21.8	29.7	38.8	60.6	86.8	117.4	152.2	
PVC080WH	110mm x 54mm Equal T Piece A-C	0.1	0.5	1.3	2.4	3.8	5.7	7.9	10.4	16.6	24.2	33.3	43.9	

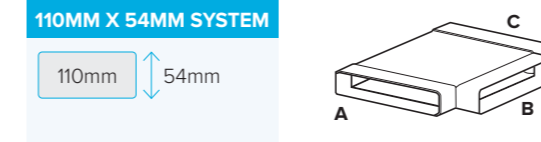

- 110x54mm Equal T Piece A-B
- 110x54mm Equal T Piece A-C

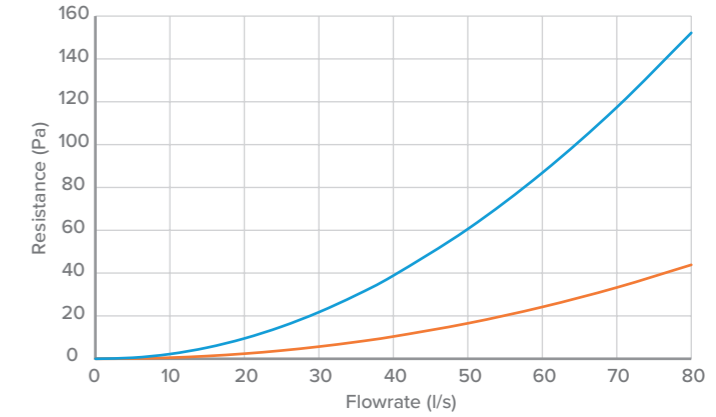

END CAP

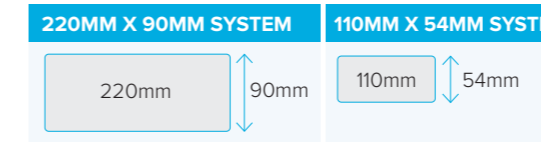

CODE	DUCT SIZE	DESCRIPTION	CONNECTION	MATERIAL	COLOUR
PVC518WH	204mm x 60mm	Rigid duct end cap	Male	HIPS (High Impact Polystyrene)	White
PVC018WH	110mm x 54mm	Rigid duct end cap	Male	HIPS (High Impact Polystyrene)	White



End caps provide a quick and easy way of terminating a duct run with an air tight seal.

DUCTMASTER RIGID

CIRCULAR

CIRCULAR DUCT 2M LENGTH

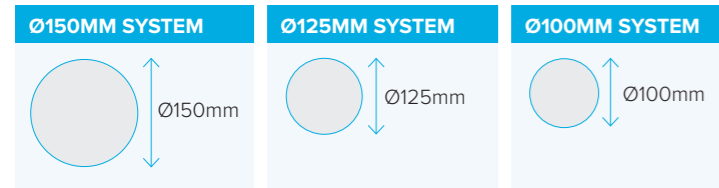

CODE	DUCT SIZE	DESCRIPTION	CONNECTION	MATERIAL	COLOUR	FLAMMABILITY RATING	MANUFACTURED TO
PVC1200-6WH	Ø150mm	2m straight length of ducting	Duct	Extruded uPVC	White	UL94V0	ISO9001
PVC1200-5WH	Ø125mm	2m straight length of ducting	Duct	Extruded uPVC	White	UL94V0	ISO9001
PVC1200-4WH	Ø100mm	2m straight length of ducting	Duct	Extruded uPVC	White	UL94V0	ISO9001

PART NUMBER	DUCT SIZE	RESISTANCE IN Pa											
		5l/s	10l/s	15l/s	20l/s	25l/s	30l/s	35l/s	40l/s	50l/s	60l/s	70l/s	80l/s
PVC1200-6WH	Ø150mm	0.0	0.1	0.2	0.3	0.4	0.5	0.7	0.9	1.3	2.0	2.8	3.8
PVC1200-5WH	Ø125mm	0.1	0.3	0.5	0.9	1.2	1.7	2.2	2.7	3.9	5.2	6.5	7.9

Ø150MM SYSTEM

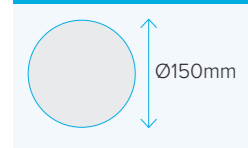

Ø125MM SYSTEM

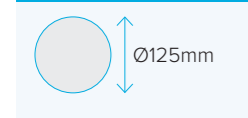

- Ø150mm
- Ø125mm

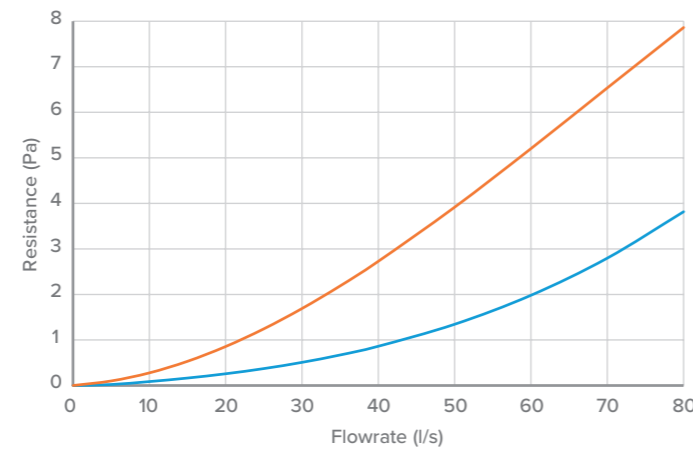

PART NUMBER	DUCT SIZE	RESISTANCE IN Pa							
		5l/s	10l/s	15l/s	20l/s	25l/s	30l/s	35l/s	40l/s
PVC1200-4WH	Ø100mm	0.2	0.6	1.3	2.2	3.4	4.8	6.4	8.2

Ø100MM SYSTEM



- Ø100mm

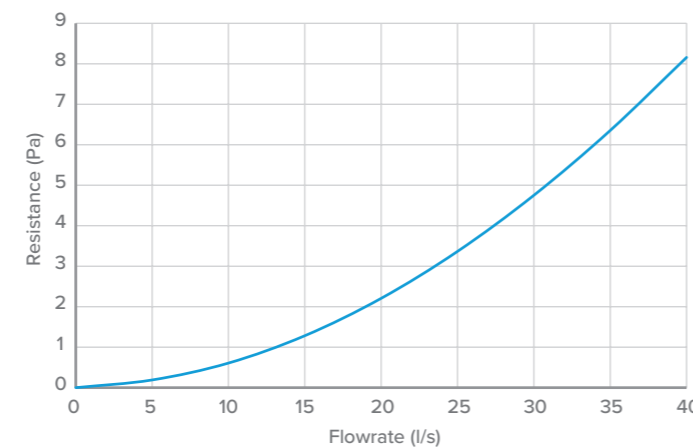

CIRCULAR DUCT 1M LENGTH

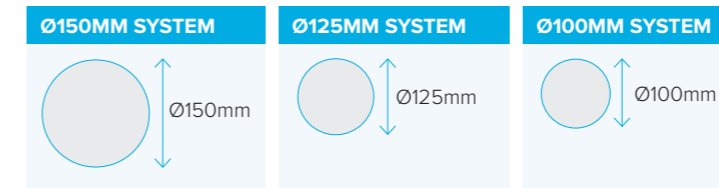

CODE	DUCT SIZE	DESCRIPTION	CONNECTION	MATERIAL	COLOUR	FLAMMABILITY RATING	MANUFACTURED TO
PVC1100-6WH	Ø150mm	1m straight length of ducting	Duct	Extruded uPVC	White	UL94V0	ISO9001
PVC1100-5WH	Ø125mm	1m straight length of ducting	Duct	Extruded uPVC	White	UL94V0	ISO9001
PVC110-4WH	Ø100mm	1m straight length of ducting	Duct	Extruded uPVC	White	UL94V0	ISO9001

PART NUMBER	DUCT SIZE	RESISTANCE IN Pa											
		5l/s	10l/s	15l/s	20l/s	25l/s	30l/s	35l/s	40l/s	50l/s	60l/s	70l/s	80l/s
PVC1100-6WH	Ø150mm	0.0	0.0	0.1	0.1	0.2	0.3	0.3	0.4	0.7	1.0	1.4	1.9
PVC1100-5WH	Ø125mm	0.0	0.1	0.3	0.4	0.6	0.8	1.1	1.4	2.0	2.6	3.3	3.9

Ø150MM SYSTEM

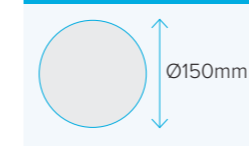

Ø125MM SYSTEM

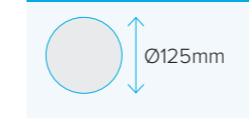

- Ø150mm
- Ø125mm

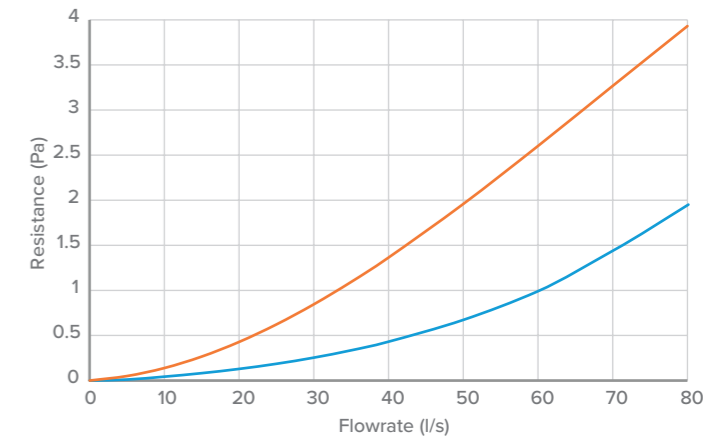

PART NUMBER	DUCT SIZE	RESISTANCE IN Pa											
		5l/s	10l/s	15l/s	20l/s	25l/s	30l/s	35l/s	40l/s	50l/s	60l/s	70l/s	80l/s
PVC1100-4WH	Ø100mm	0.1	0.3	0.6	1.1	1.7	2.4	3.2	4.1	6.2	8.6	11.3	14.3

Ø100MM SYSTEM

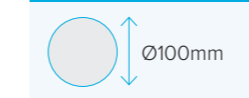

- Ø100mm

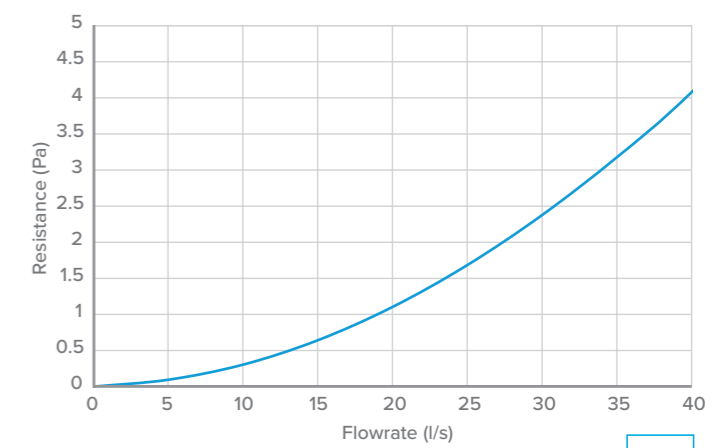

TELESCOPIC ASSEMBLY DUCT

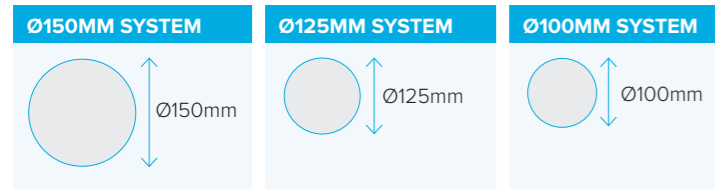

CODE	DUCT SIZE	DESCRIPTION	CONNECTION	MATERIAL	COLOUR	FLAMMABILITY RATING	MANUFACTURED TO
PVC130-6WH	Ø150mm	Telescopic straight duct length 0.25-0.45m	Duct	Extruded uPVC	White	UL94V0	ISO9001
PVC130-5WH	Ø125mm	Telescopic straight duct length 0.25-0.45m	Duct	Extruded uPVC	White	UL94V0	ISO9001
PVC130-4WH	Ø100mm	Telescopic straight duct length 0.25-0.45m	Duct	Extruded uPVC	White	UL94V0	ISO9001

For further information please contact our Design Team at residentialenquiries@nuaire.co.uk

DUCT CONNECTOR

CODE	DUCT SIZE	DESCRIPTION	CONNECTION	MATERIAL	COLOUR	FLAMMABILITY RATING	MANUFACTURED TO
CON200	Ø200mm	Straight duct connector	Female	HIPS (High Impact Polystyrene)	White	UL94-HB	ISO9001



DUCT CONNECTOR

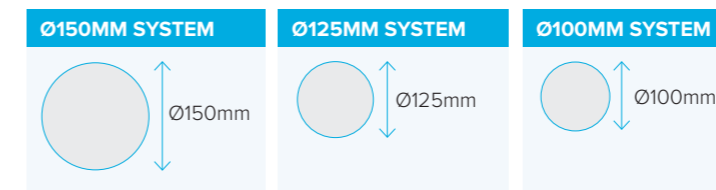

CODE	DUCT SIZE	DESCRIPTION	CONNECTION	MATERIAL	COLOUR	FLAMMABILITY RATING	MANUFACTURED TO
PVC693WH	Ø150mm	Straight duct connector	Male	HIPS (High Impact Polystyrene)	White	UL94HB	ISO9001
PVC593WH	Ø125mm	Straight duct connector	Male	HIPS (High Impact Polystyrene)	White	UL94HB	ISO9001
PVC493WH	Ø100mm	Straight duct connector	Male	HIPS (High Impact Polystyrene)	White	UL94HB	ISO9001

PART NUMBER	DUCT SIZE	RESISTANCE IN Pa											
		5l/s	10l/s	15l/s	20l/s	25l/s	30l/s	35l/s	40l/s	50l/s	60l/s	70l/s	80l/s
PVC693WH	Ø150mm	0.0	0.0	0.0	0.1	0.1	0.1	0.2	0.2	0.3	0.5	0.7	0.9
PVC593WH	Ø125mm	0.0	0.0	0.1	0.1	0.2	0.3	0.5	0.7	1.1	1.6	2.3	3.0

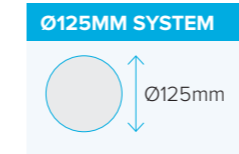
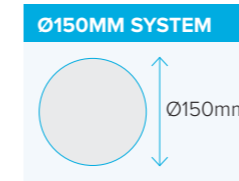

— Ø150mm
— Ø125mm

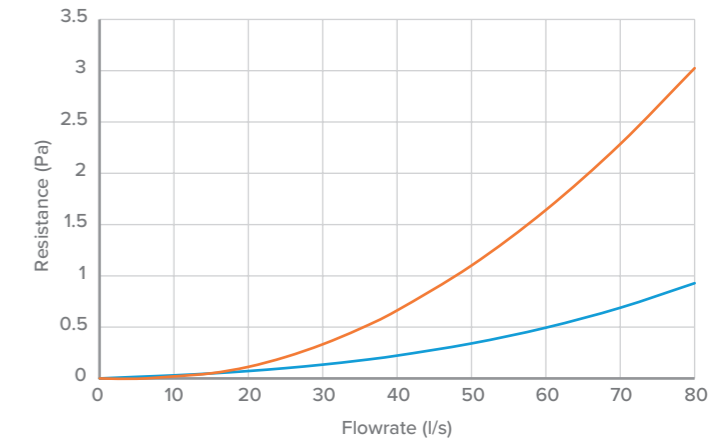

PART NUMBER	DUCT SIZE	RESISTANCE IN Pa							
		5l/s	10l/s	15l/s	20l/s	25l/s	30l/s	35l/s	40l/s
PVC493WH	Ø100mm	0.0	0.2	0.5	0.8	1.2	1.8	2.4	3.0

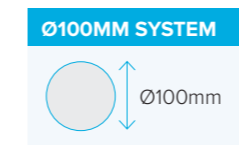

— Ø100mm

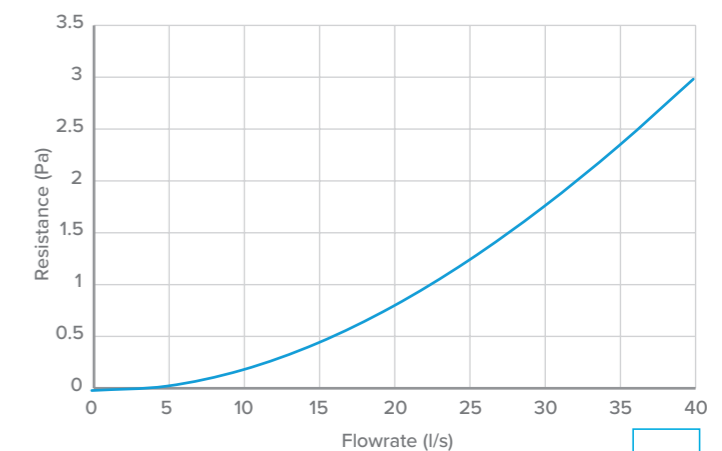

90° BEND

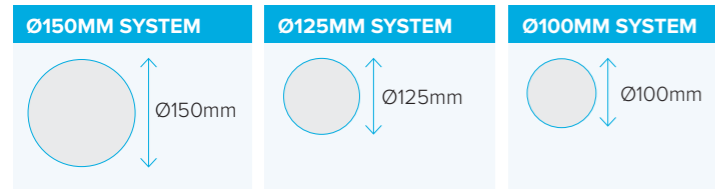

CODE	DUCT SIZE	DESCRIPTION	CONNECTION	MATERIAL	COLOUR	FLAMMABILITY RATING	MANUFACTURED TO
PVC690WH	Ø150mm	Rigid duct 90° bend	Male	HIPS (High Impact Polystyrene)	White	UL94HB	ISO9001
PVC590WH	Ø125mm	Rigid duct 90° bend	Male	HIPS (High Impact Polystyrene)	White	UL94HB	ISO9001
PVC490WH	Ø100mm	Rigid duct 90° bend	Male	HIPS (High Impact Polystyrene)	White	UL94HB	ISO9001

PART NUMBER	DUCT SIZE	RESISTANCE IN Pa											
		5l/s	10l/s	15l/s	20l/s	25l/s	30l/s	35l/s	40l/s	50l/s	60l/s	70l/s	80l/s
PVC690WH	Ø150mm	0.1	0.3	0.6	1.1	1.8	2.6	3.5	4.6	7.1	9.9	13.1	16.6
PVC590WH	Ø125mm	0.1	0.4	1.0	1.8	2.9	4.2	5.7	7.3	11.3	15.8	20.9	26.4

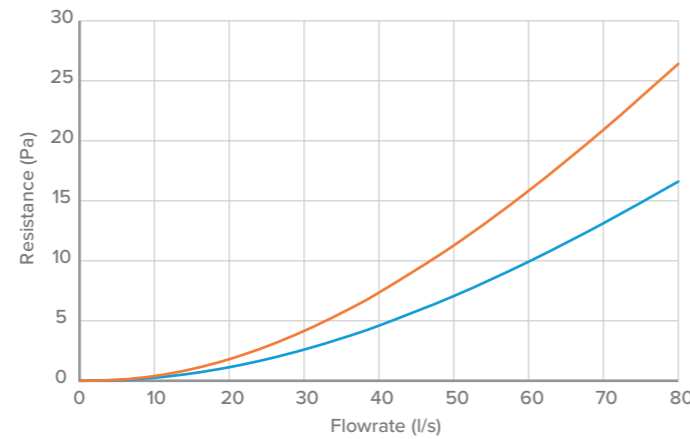
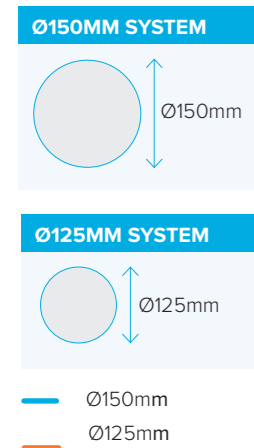

PART NUMBER	DUCT SIZE	RESISTANCE IN Pa							
		5l/s	10l/s	15l/s	20l/s	25l/s	30l/s	35l/s	40l/s
PVC490WH	Ø100mm	0.3	1.3	3.0	5.4	8.4	12.0	16.1	20.7

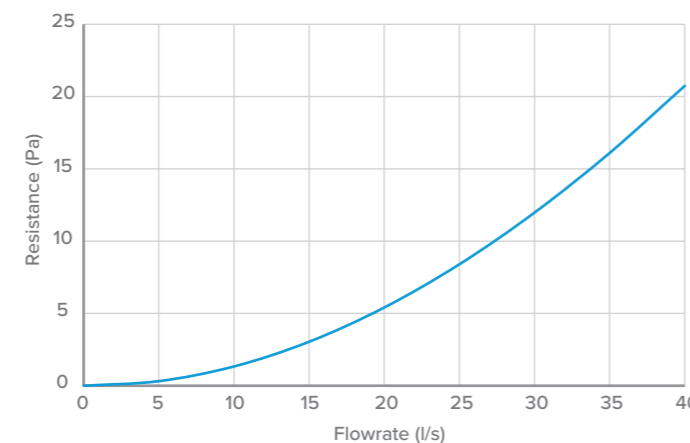
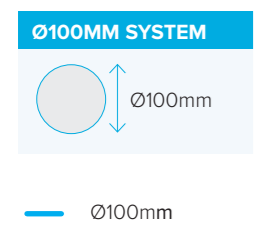

45° BEND

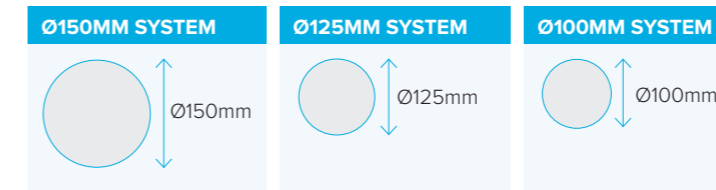

CODE	DUCT SIZE	DESCRIPTION	CONNECTION	MATERIAL	COLOUR	FLAMMABILITY RATING	MANUFACTURED TO
PVC691WH	Ø150mm	Rigid duct 45° bend	Male	HIPS (High Impact Polystyrene)	White	UL94HB	ISO9001
PVC591WH	Ø125mm	Rigid duct 45° bend	Male	HIPS (High Impact Polystyrene)	White	UL94HB	ISO9001
PVC491WH	Ø100mm	Rigid duct 45° bend	Male	HIPS (High Impact Polystyrene)	White	UL94HB	ISO9001

PART NUMBER	DUCT SIZE	RESISTANCE IN Pa											
		5l/s	10l/s	15l/s	20l/s	25l/s	30l/s	35l/s	40l/s	50l/s	60l/s	70l/s	80l/s
PVC691WH	Ø150mm	0.0	0.1	0.2	0.3	0.4	0.6	0.9	1.1	1.8	2.5	3.4	4.4
PVC591WH	Ø125mm	0.0	0.1	0.3	0.5	0.7	1.0	1.4	1.9	3.0	4.4	6.1	8.3

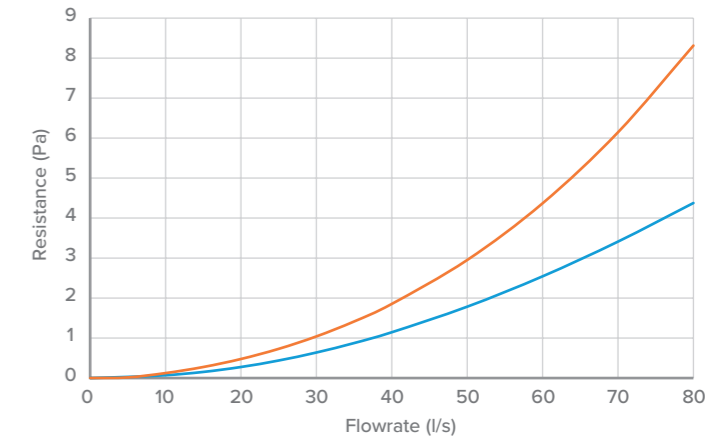
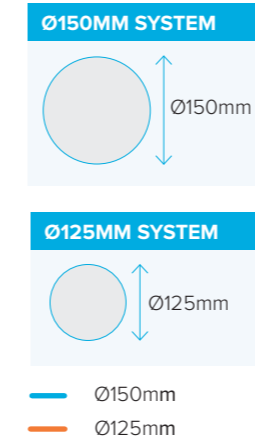

PART NUMBER	DUCT SIZE	RESISTANCE IN Pa											
		5l/s	10l/s	15l/s	20l/s	25l/s	30l/s	35l/s	40l/s	50l/s	60l/s	70l/s	80l/s
PVC491WH	Ø100mm	0.1	0.5	1.0	1.7	2.5	3.5	4.7	5.9	8.6	11.6	14.6	17.7

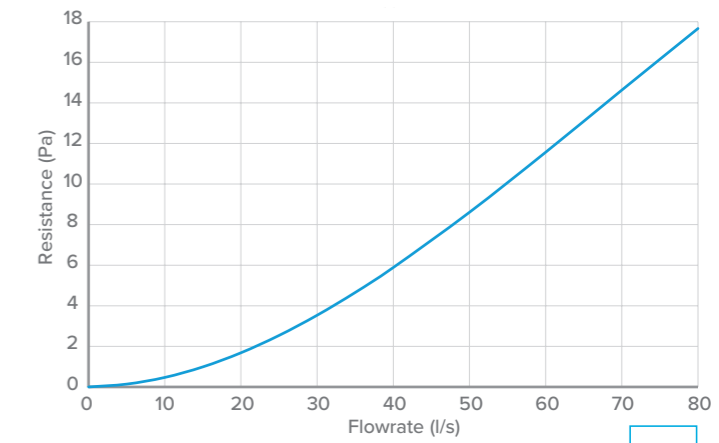
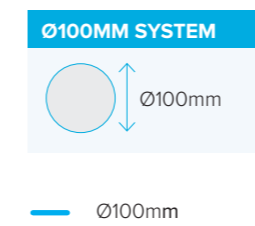

STRAIGHT CONNECTOR WITH DAMPER

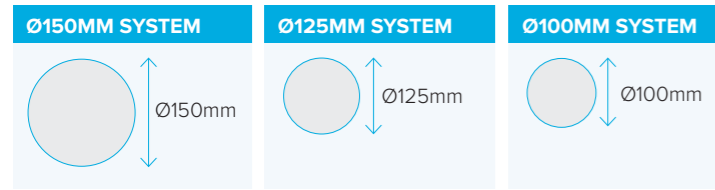

CODE	DUCT SIZE	DESCRIPTION	CONNECTION	MATERIAL	COLOUR	FLAMMABILITY RATING	MANUFACTURED TO
PVC694WH	Ø150mm	Straight connector with damper	Male	HIPS (High Impact Polystyrene)	White	UL94HB	ISO9001
PVC594WH	Ø125mm	Straight connector with damper	Male	HIPS (High Impact Polystyrene)	White	UL94HB	ISO9001
PVC494WH	Ø100mm	Straight connector with damper	Male	HIPS (High Impact Polystyrene)	White	UL94HB	ISO9001

PART NUMBER	DUCT SIZE	RESISTANCE IN Pa											
		5l/s	10l/s	15l/s	20l/s	25l/s	30l/s	35l/s	40l/s	50l/s	60l/s	70l/s	80l/s
PVC694WH	Ø150mm	3.9	6.8	9.3	11.5	13.5	15.3	16.9	18.4	21.4	24.7	28.7	33.9
PVC594WH	Ø125mm	4.9	8.5	11.7	14.5	17.0	19.4	21.5	23.6	27.8	32.3	37.9	44.9

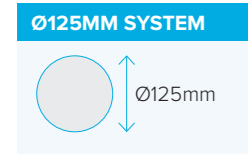
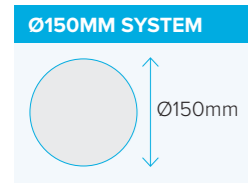

— Ø150mm
— Ø125mm

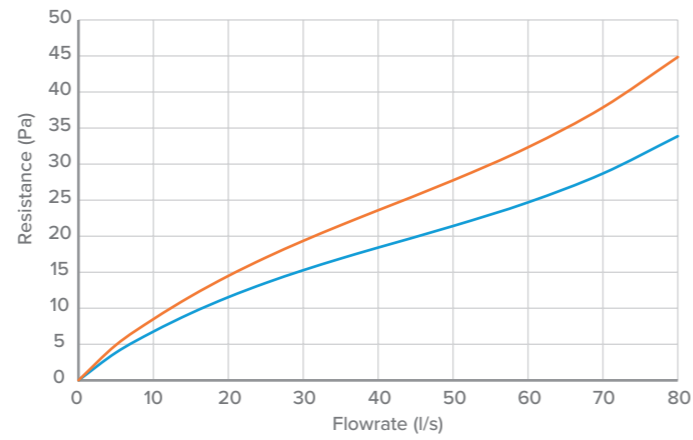

PART NUMBER	DUCT SIZE	RESISTANCE IN Pa							
		5l/s	10l/s	15l/s	20l/s	25l/s	30l/s	35l/s	40l/s
PVC494WH	Ø100mm	4.6	7.7	10.3	12.5	14.8	17.4	20.8	25.2

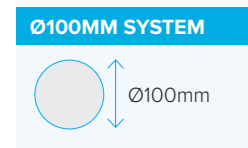

— Ø100mm

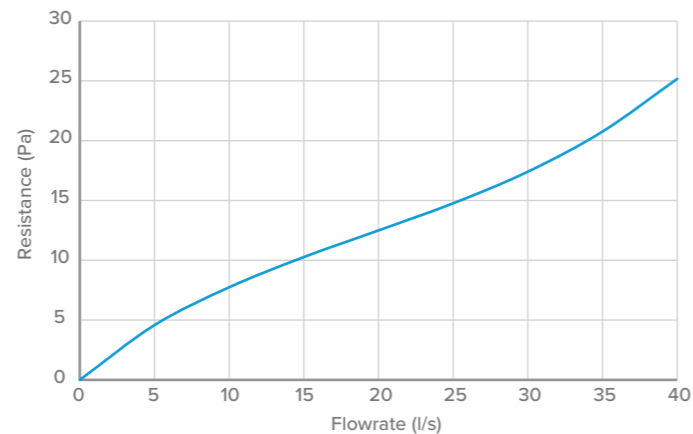

DUCT CLIP

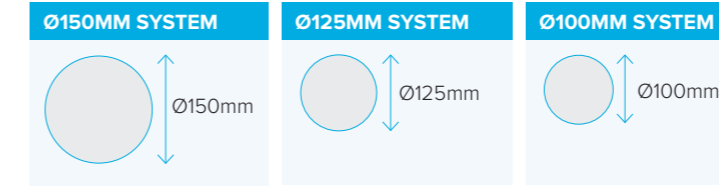

CODE	DUCT SIZE	DESCRIPTION	MATERIAL	COLOUR
PVC696WH	Ø150mm	Circular duct clip	HIPS (High Impact Polystyrene)	White
PVC596WH	Ø125mm	Circular duct clip	HIPS (High Impact Polystyrene)	White
PVC496WH	Ø100mm	Circular duct clip	HIPS (High Impact Polystyrene)	White

- Duct clips are an effective part of the overall duct system and quickly fasten into place.
- Duct clips securely hold duct runs and prevent them from bobbing.

WALL PLATE

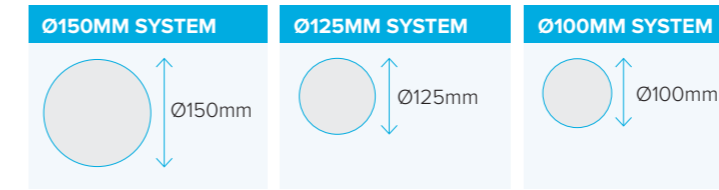

CODE	DUCT SIZE	DESCRIPTION	MATERIAL	COLOUR
PVC114-6WH	Ø150mm	Rigid duct wall plate	HIPS (High Impact Polystyrene)	White
PVC114-5WH	Ø125mm	Rigid duct wall plate	HIPS (High Impact Polystyrene)	White
PVC114-4WH	Ø100mm	Rigid duct wall plate	HIPS (High Impact Polystyrene)	White

- For installation between the duct run and external terminal, these wall plates are a simple way to ensure the duct is securely supported and held in place.

T-PIECE

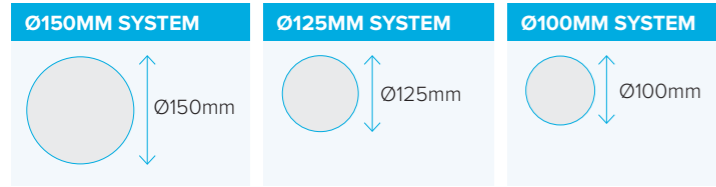

CODE	DUCT SIZE	DESCRIPTION	CONNECTION	MATERIAL	COLOUR	FLAMMABILITY RATING	MANUFACTURED TO
PVC692M	Ø150mm	T-Piece	Male	HIPS (High Impact Polystyrene)	White	UL94HB	ISO9001
PVC592M	Ø125mm	T-Piece	Male	HIPS (High Impact Polystyrene)	White	UL94HB	ISO9001
PVC492M	Ø100mm	T-Piece	Male	HIPS (High Impact Polystyrene)	White	UL94HB	ISO9001

PART NUMBER	DUCT SIZE	RESISTANCE IN Pa												
		5l/s	10l/s	15l/s	20l/s	25l/s	30l/s	35l/s	40l/s	50l/s	60l/s	70l/s	80l/s	
PVC692WH	Ø150mm Equal T Piece A-B	0.0	0.1	0.2	0.3	0.5	1.0	1.7	2.6	4.9	7.6	10.8	14.5	
PVC692WH	Ø150mm Equal T Piece A-C	0.0	0.0	0.0	0.0	0.0	0.2	0.4	0.7	1.4	2.2	3.3	4.5	

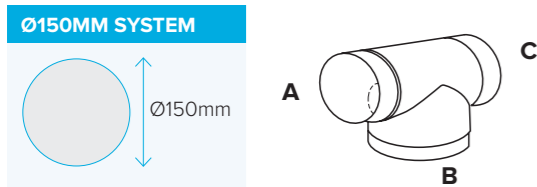

- Ø150mm Equal T Piece A-B
- Ø150mm Equal T Piece A-C

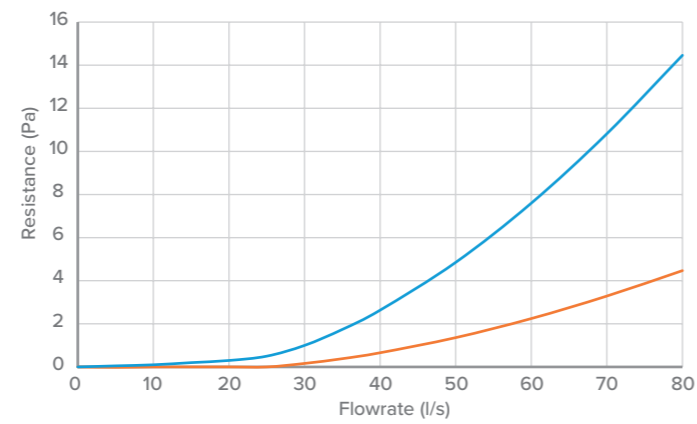

PART NUMBER	DUCT SIZE	RESISTANCE IN Pa												
		5l/s	10l/s	15l/s	20l/s	25l/s	30l/s	35l/s	40l/s	50l/s	60l/s	70l/s	80l/s	
PVC592WH	Ø125mm Equal T Piece A-B	0.0	0.1	0.6	1.4	2.3	3.6	5.0	6.6	10.5	15.3	20.7	27.0	
PVC592WH	Ø125mm Equal T Piece A-C	0.01	0.05	0.1	0.3	0.6	0.9	1.2	1.7	2.7	4.0	5.6	7.4	

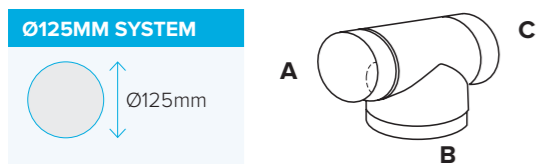

- Ø125mm Equal T Piece A-B
- Ø125mm Equal T Piece A-C

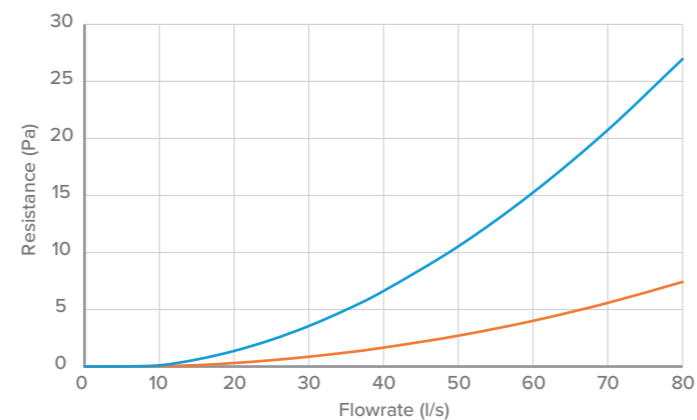

PART NUMBER	DUCT SIZE	RESISTANCE IN Pa												
		5l/s	10l/s	15l/s	20l/s	25l/s	30l/s	35l/s	40l/s	50l/s	60l/s	70l/s	80l/s	
PVC492WH	Ø100mm Equal T Piece A-B	0.0	0.8	2.4	4.7	7.8	11.5	16.0	21.2	33.7	48.9	66.8	87.3	
PVC492WH	Ø100mm Equal T Piece A-C	0.0	0.0	0.6	1.1	2.1	3.4	4.8	6.4	10.1	14.1	18.3	22.5	

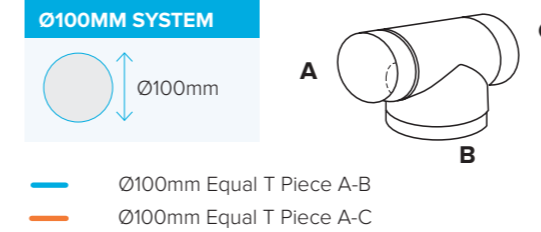

- Ø100mm Equal T Piece A-B
- Ø100mm Equal T Piece A-C

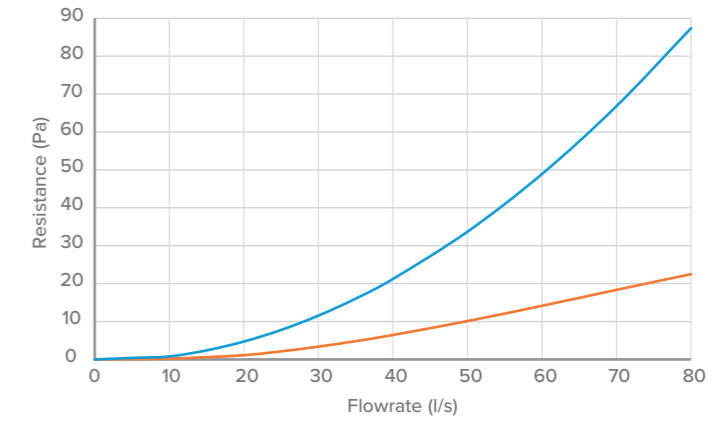



DUCTMASTER RIGID PLENUMS

FIXED SPIGOT PLENUM, RECTANGULAR TO ROUND 220X90MM - Ø125MM

CODE	AIR DIRECTION		DESCRIPTION	CONNECTION	MATERIAL	COLOUR	FLAMMABILITY RATING	MANUFACTURED TO
	From	To						
PVC940WH	220mm x 90mm	Ø125mm	Fixed spigot plenum	Female / Male	PVC	White	UL94HB	ISO9001

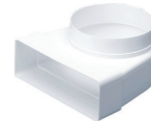

PART NUMBER	AIR DIRECTION	RESISTANCE IN Pa											
		5l/s	10l/s	15l/s	20l/s	25l/s	30l/s	35l/s	40l/s	50l/s	60l/s	70l/s	80l/s
PVC940WH	Rect to Round	0.2	0.8	1.8	3.2	5.1	7.3	9.9	12.9	20.1	28.9	39.3	51.3
	Round to Rect	0.3	1.0	2.3	4.1	6.3	9.1	12.4	16.1	25.0	35.6	48.0	61.9

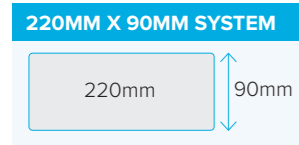

— Rect to Round
— Round to Rect

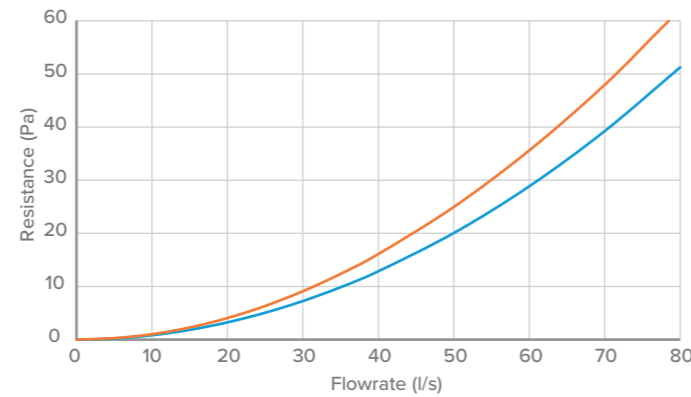

FIXED SPIGOT PLENUM, RECTANGULAR TO ROUND 204X60MM - Ø100MM

CODE	AIR DIRECTION		DESCRIPTION	CONNECTION	MATERIAL	COLOUR	FLAMMABILITY RATING	MANUFACTURED TO
	From	To						
PVC440WH	204mm x 60mm	Ø100mm	Fixed spigot plenum	Female / Male	PVC	White	UL94HB	ISO9001

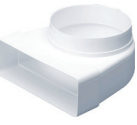

PART NUMBER	AIR DIRECTION	RESISTANCE IN Pa											
		5l/s	10l/s	15l/s	20l/s	25l/s	30l/s	35l/s	40l/s	50l/s	60l/s	70l/s	80l/s
PVC440WH	Rect to Round	0.1	0.7	2.4	5.0	8.6	13.0	18.3	24.4	39.2	57.1	78.1	102.0
	Round to Rect	1.0	3.1	6.1	10.3	15.7	22.3	30.2	39.4	62.1	90.9	126.2	168.5



— Rect to Round
— Round to Rect

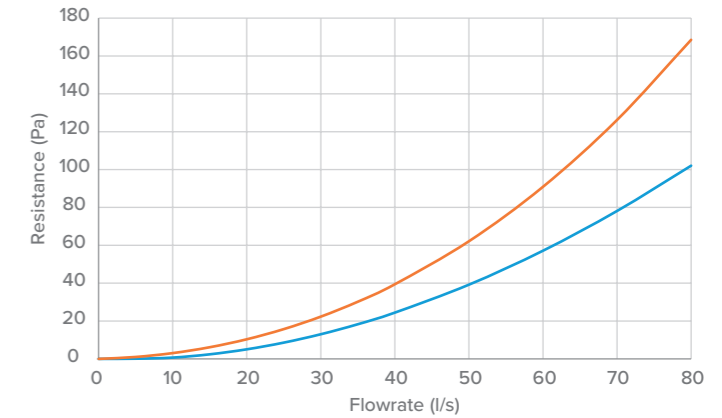

FIXED SPIGOT PLENUM, RECTANGULAR TO ROUND 204X60MM - Ø125MM

CODE	AIR DIRECTION		DESCRIPTION	CONNECTION	MATERIAL	COLOUR	FLAMMABILITY RATING	MANUFACTURED TO
	From	To						
PVC540WH	204mm x 60mm	Ø125mm	Fixed spigot plenum	Female / Male	PVC	White	UL94HB	ISO9001

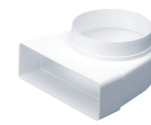

PART NUMBER	AIR DIRECTION	RESISTANCE IN Pa											
		5l/s	10l/s	15l/s	20l/s	25l/s	30l/s	35l/s	40l/s	50l/s	60l/s	70l/s	80l/s
PVC540WH	Rect to Round	0.1	0.6	1.6	3.0	4.8	6.9	9.3	12.0	18.	25.3	32.9	40.9
	Round to Rect	0.3	1.3	3.2	6.1	9.7	14.2	19.4	25.4	39.5	56.3	75.3	96.5

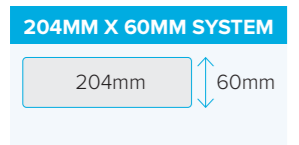

— Rect to round
— Round to rect

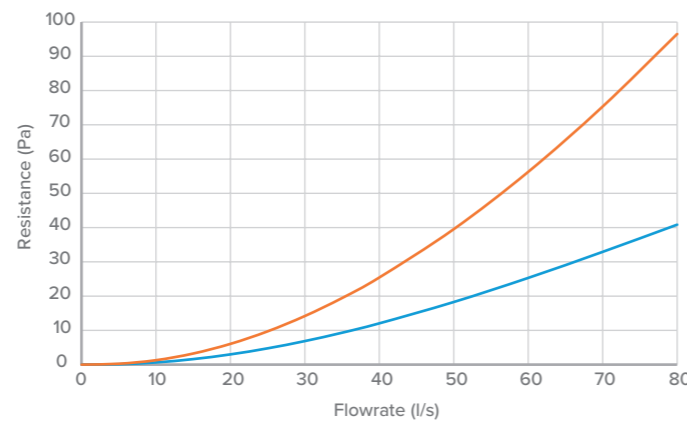

FIXED SPIGOT PLENUM, RECTANGULAR TO ROUND 110X54MM - Ø100MM

CODE	AIR DIRECTION		DESCRIPTION	CONNECTION	MATERIAL	COLOUR	FLAMMABILITY RATING	MANUFACTURED TO
	From	To						
PVC030WH	110mm x 54mm	Ø100mm	Fixed spigot plenum	Female / Male	PVC	White	UL94HB	ISO9001

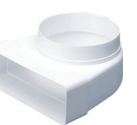

PART NUMBER	AIR DIRECTION	RESISTANCE IN Pa							
		5l/s	10l/s	15l/s	20l/s	25l/s	30l/s	35l/s	40l/s
PVC030WH	Rect to Round	0.3	1.3	3.0	5.2	8.1	11.6	15.7	20.3
	Round to Rect	1.4	5.2	11.5	20.3	31.6	45.4	61.6	80.3

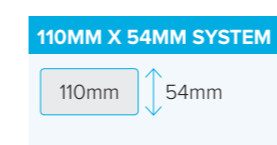

— Rect to Round
— Round to Rect

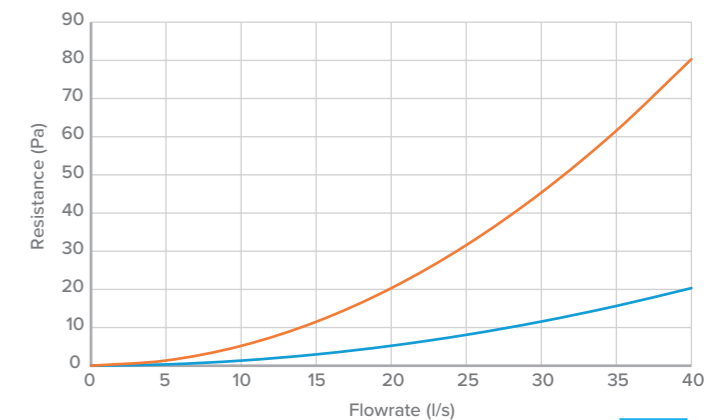



OFFSET ROTATING SPIGOT PLENUM, RECTANGULAR TO ROUND 220X90MM - Ø150MM

CODE	AIR DIRECTION		DESCRIPTION	CONNECTION	MATERIAL	COLOUR	FLAMMABILITY RATING	MANUFACTURED TO
	From	To						
PVC961WH	220mm x 90mm	Ø150mm	Offset rotating spigot plenum	Female / Male	PVC	White	UL94HB	ISO9001



PART NUMBER	AIR DIRECTION	RESISTANCE IN Pa											
		5l/s	10l/s	15l/s	20l/s	25l/s	30l/s	35l/s	40l/s	50l/s	60l/s	70l/s	80l/s
PVC961WH	Intake (A) - Rect to Round	0.1	0.4	0.8	1.5	2.3	3.3	4.4	5.7	8.9	12.8	17.3	22.6
	Exhaust (A) - Round to Rect	0.2	0.7	1.5	2.6	4.1	5.8	7.8	10.2	15.8	22.7	30.9	40.4
	Intake (B) - Rect to Round	0.0	0.3	1.0	2.0	3.4	5.1	7.3	9.7	15.8	23.4	32.6	43.5
	Exhaust (B) - Round to Rect	0.2	0.9	1.9	3.3	5.0	7.2	9.7	12.7	19.9	28.7	39.3	51.6

A = spigot furthest from socket B = spigot nearest to socket

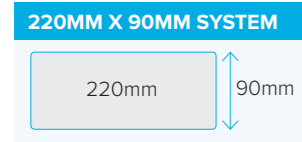

- Intake (A) - Rect to Round
- Exhaust (A) - Round to Rect
- Intake (B) - Rect to Round
- Exhaust (B) - Round to Rect

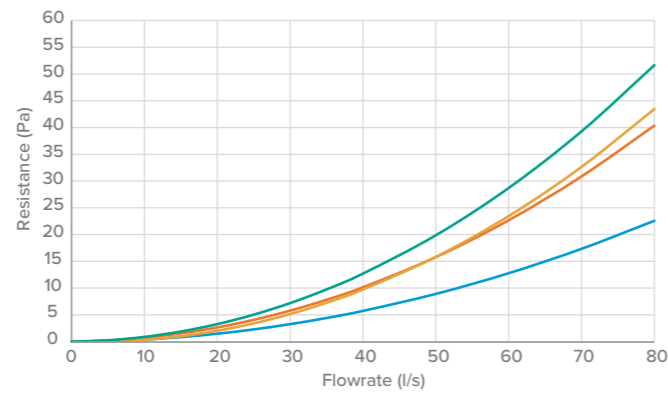

OFFSET ROTATING SPIGOT PLENUM, RECTANGULAR TO ROUND 220X90MM - Ø100MM

CODE	AIR DIRECTION		DESCRIPTION	CONNECTION	MATERIAL	COLOUR	FLAMMABILITY RATING	MANUFACTURED TO
	From	To						
PVC941WH	220mm x 90mm	Ø100mm	Offset rotating spigot plenum	Female / Male	PVC	White	UL94HB	ISO9001



PART NUMBER	AIR DIRECTION	RESISTANCE IN Pa							
		5l/s	10l/s	15l/s	20l/s	25l/s	30l/s	35l/s	40l/s
PVC941WH	Intake (A) - Rect to Round	0.5	2.1	4.7	8.3	13.0	18.6	25.2	32.7
	Exhaust (A) - Round to Rect	0.7	2.3	4.8	8.4	13.1	18.9	26.0	34.4
	Intake (B) - Rect to Round	0.7	2.9	6.7	12.5	20.4	30.7	43.7	59.7
	Exhaust (B) - Round to Rect	0.7	2.7	6.1	10.9	17.2	25.1	34.5	45.5

A = spigot furthest from socket B = spigot nearest to socket

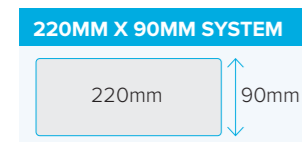

- Intake (A) - Rect to Round
- Exhaust (A) - Round to Rect
- Intake (B) - Rect to Round
- Exhaust (B) - Round to Rect

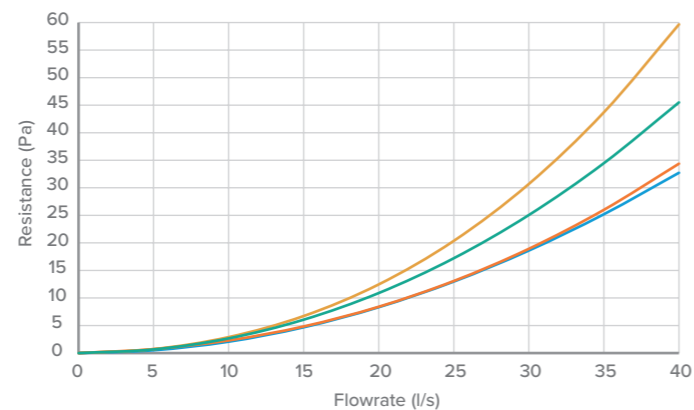

OFFSET ROTATING SPIGOT PLENUM, RECTANGULAR TO ROUND 204X60MM - Ø150MM

CODE	AIR DIRECTION		DESCRIPTION	CONNECTION	MATERIAL	COLOUR	FLAMMABILITY RATING	MANUFACTURED TO
	From	To						
PVC641WH	204mm x 60mm	Ø150mm	Offset rotating spigot plenum	Female / Male	PVC	White	UL94HB	ISO9001

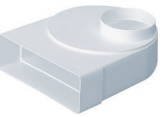

PART NUMBER	AIR DIRECTION	RESISTANCE IN Pa											
		5l/s	10l/s	15l/s	20l/s	25l/s	30l/s	35l/s	40l/s	50l/s	60l/s	70l/s	80l/s
PVC641WH	Intake (A) - Rect to Round	0.0	0.2	0.6	1.1	1.8	2.6	3.5	4.5	6.8	9.3	11.8	14.3
	Exhaust (A) - Round to Rect	0.3	1.2	2.7	4.6	7.0	10.0	13.5	17.4	27.0	38.6	52.3	68.1
	Intake (B) - Rect to Round	0.1	0.2	0.9	2.0	3.5	5.3	7.5	9.9	15.8	22.8	30.6	39.3
	Exhaust (B) - Round to Rect	0.3	1.2	2.6	4.5	7.0	10.0	13.5	17.6	27.4	39.5	53.8	70.6

A = spigot furthest from socket B = spigot nearest to socket



- Intake (A) - Rect to Round
- Exhaust (A) - Round to Rect
- Intake (B) - Rect to Round
- Exhaust (B) - Round to Rect

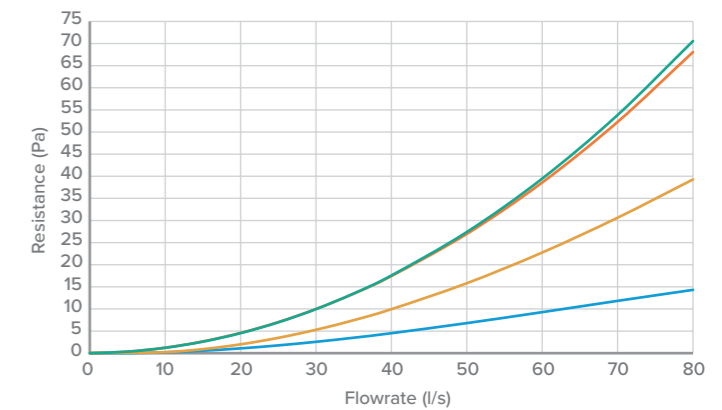

OFFSET ROTATING SPIGOT PLENUM, RECTANGULAR TO ROUND 204X60MM - Ø125MM

CODE	AIR DIRECTION		DESCRIPTION	CONNECTION	MATERIAL	COLOUR	FLAMMABILITY RATING	MANUFACTURED TO
	From	To						
PVC541WH	204mm x 60mm	Ø125mm	Offset rotating spigot plenum	Female / Male	PVC	White	UL94HB	ISO9001

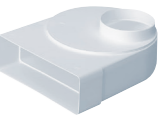

PART NUMBER	AIR DIRECTION	RESISTANCE IN Pa											
		5l/s	10l/s	15l/s	20l/s	25l/s	30l/s	35l/s	40l/s	50l/s	60l/s	70l/s	80l/s
PVC541WH	Intake (A) - Rect to Round	0.2	0.7	1.6	2.8	4.4	6.3	8.5	11.0	16.7	23.2	30.5	38.2
	Exhaust (A) - Round to Rect	0.4	1.6	3.4	6.1	9.4	13.5	18.4	23.9	37.3	53.7	73.1	95.4
	Intake (B) - Rect to Round	0.2	0.5	2.2	4.9	8.7	13.4	19.2	25.9	42.2	62.2	85.8	112.9
	Exhaust (B) - Round to Rect	0.5	1.8	3.7	6.4	9.8	14.0	19.1	25.0	39.4	57.5	79.6	105.8

A = spigot furthest from socket B = spigot nearest to socket

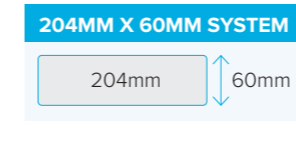

- Intake (A) - Rect to Round
- Exhaust (A) - Round to Rect
- Intake (B) - Rect to Round
- Exhaust (B) - Round to Rect

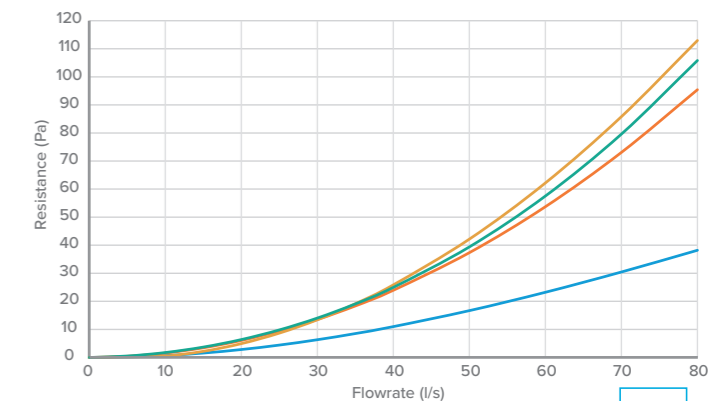

DUCTMASTER RIGID

ADAPTING PIECES

IN-LINE ADAPTER, RECTANGULAR TO RECTANGULAR 220X90MM - 204X60MM

CODE	DUCT SIZE		DESCRIPTION	CONNECTION	MATERIAL	COLOUR	FLAMMABILITY RATING	MANUFACTURED TO
	From	To						
PVC957WH	220mm x 90mm	204mm x 60mm	In-line adapter rectangular to rectangular	Duct / Female	PVC	White	UL94HB	ISO9001

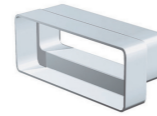

PART NUMBER	DUCT SIZE		RESISTANCE IN Pa												
			5l/s	10l/s	15l/s	20l/s	25l/s	30l/s	35l/s	40l/s	50l/s	60l/s	70l/s	80l/s	
PVC957WH	From	To	0.1	0.4	0.8	1.5	2.3	3.3	4.4	5.7	8.8	12.6	17.1	22.2	
	220mm x 90mm	204mm x 60mm													

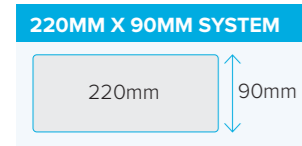

— 220x90mm

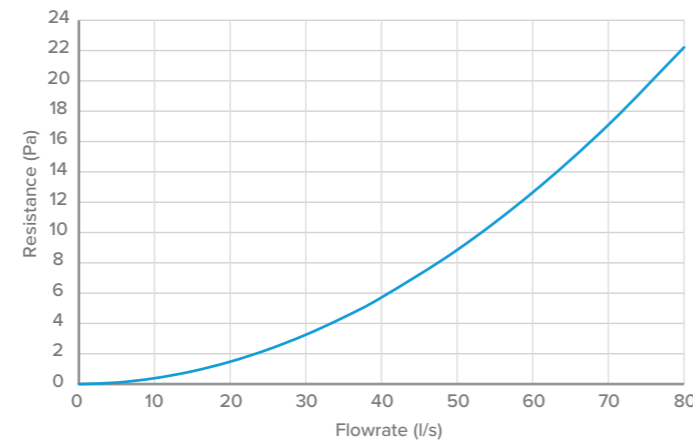

IN-LINE ROUND REDUCER Ø150MM - Ø125MM

CODE	DUCT SIZE		DESCRIPTION	CONNECTION	MATERIAL	COLOUR	FLAMMABILITY RATING	MANUFACTURED TO
	From	To						
PVC118WH	Ø150mm	Ø125mm	In-line round PVC duct reducer	Female	HIPS (High Impact Polystyrene)	White	UL94V0	ISO9001



PART NUMBER	DUCT SIZE		RESISTANCE IN Pa												
			5l/s	10l/s	15l/s	20l/s	25l/s	30l/s	35l/s	40l/s	50l/s	60l/s	70l/s	80l/s	
PVC118WH	From	To	0.1	0.2	0.5	0.9	1.4	2.0	2.7	3.5	5.4	7.7	10.3	13.2	
	Ø150mm	Ø125mm													

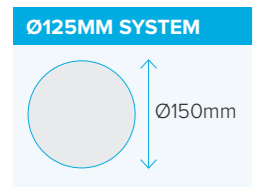

— Ø150mm - Ø125mm

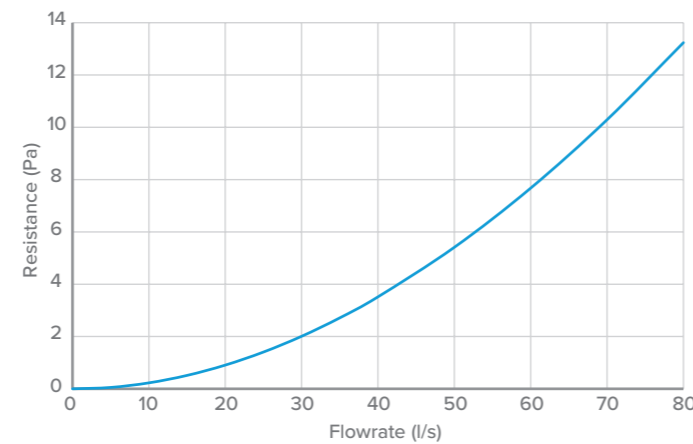

IN-LINE ROUND REDUCER Ø150MM - Ø100MM

CODE	DUCT SIZE		DESCRIPTION	CONNECTION	MATERIAL	COLOUR	FLAMMABILITY RATING	MANUFACTURED TO
	From	To						
PVC619WH	Ø150mm	Ø100mm	In-line round PVC duct reducer	Female	HIPS (High Impact Polystyrene)	White	UL94V0	ISO9001



PART NUMBER	DUCT SIZE		RESISTANCE IN Pa												
			5l/s	10l/s	15l/s	20l/s	25l/s	30l/s	35l/s	40l/s	50l/s	60l/s	70l/s	80l/s	
PVC619WH	From	To	0.2	0.8	2.0	3.4	5.0	6.9	9.4	12.0	18.8	27.0	36.8	48.0	
	Ø150mm	Ø100mm													

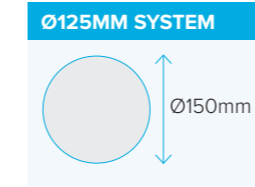

— Ø150mm - Ø100mm

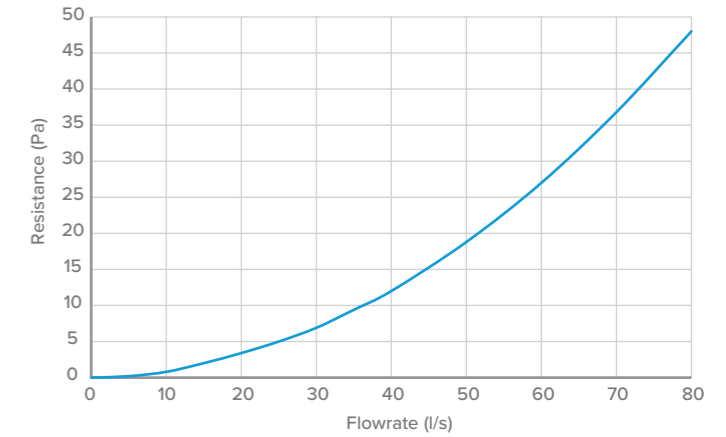

IN-LINE ROUND REDUCER Ø125MM - Ø100MM

CODE	DUCT SIZE		DESCRIPTION	CONNECTION	MATERIAL	COLOUR	FLAMMABILITY RATING	MANUFACTURED TO
	From	To						
PVC119WH	Ø125mm	Ø100mm	In-line round PVC duct reducer	Female	HIPS (High Impact Polystyrene)	White	UL94V0	ISO9001



PART NUMBER	DUCT SIZE		RESISTANCE IN Pa												
			5l/s	10l/s	15l/s	20l/s	25l/s	30l/s	35l/s	40l/s	50l/s	60l/s	70l/s	80l/s	
PVC119WH	From	To	0.1	0.7	1.6	2.9	4.6	6.7	9.1	11.8	18.2	25.6	33.9	43.0	
	Ø125mm	Ø100mm													

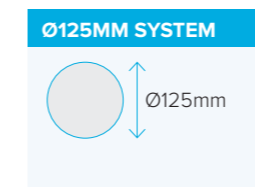

— Ø125mm - Ø100mm

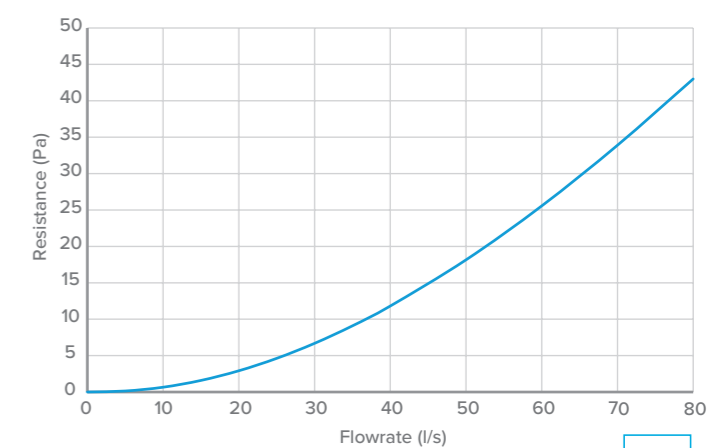

STEEL ROUND REDUCER Ø200MM - Ø150MM

CODE	DUCT SIZE		DESCRIPTION	CONNECTION	MATERIAL	COLOUR	FLAMMABILITY RATING	MANUFACTURED TO
	From	To						
RED200X150	Ø200mm	Ø150mm	In-line round steel duct reducer	Male	Steel	Steel	-	ISO9001



PART NUMBER	DUCT SIZE		RESISTANCE IN Pa												
			5l/s	10l/s	15l/s	20l/s	25l/s	30l/s	35l/s	40l/s	50l/s	60l/s	70l/s	80l/s	
RED200X150	From	To	0.1	0.1	0.2	0.3	0.4	0.5	0.7	0.9	1.4	2.0	2.7	3.6	
	Ø200mm	Ø150mm													

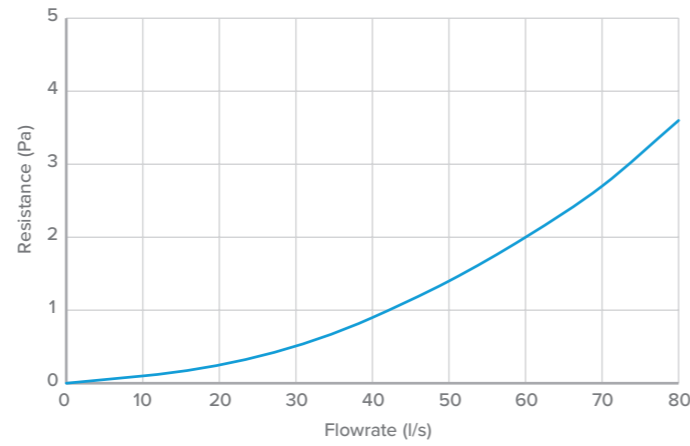
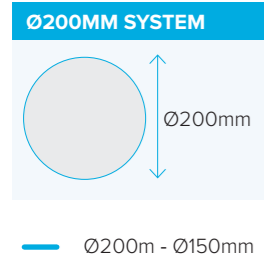

STEEL ROUND REDUCER Ø180MM - Ø125MM

CODE	DUCT SIZE		DESCRIPTION	CONNECTION	MATERIAL	COLOUR	FLAMMABILITY RATING	MANUFACTURED TO
	From	To						
RED180X125	Ø180mm	Ø125mm	In-line round steel duct reducer	Male	Steel	Steel	-	ISO9001



PART NUMBER	DUCT SIZE		RESISTANCE IN Pa												
			5l/s	10l/s	15l/s	20l/s	25l/s	30l/s	35l/s	40l/s	50l/s	60l/s	70l/s	80l/s	
RED180X125	From	To	0.1	0.2	0.4	0.7	1.1	1.5	2.1	2.7	4.2	6.0	8.2	10.7	
	Ø180mm	Ø125mm													

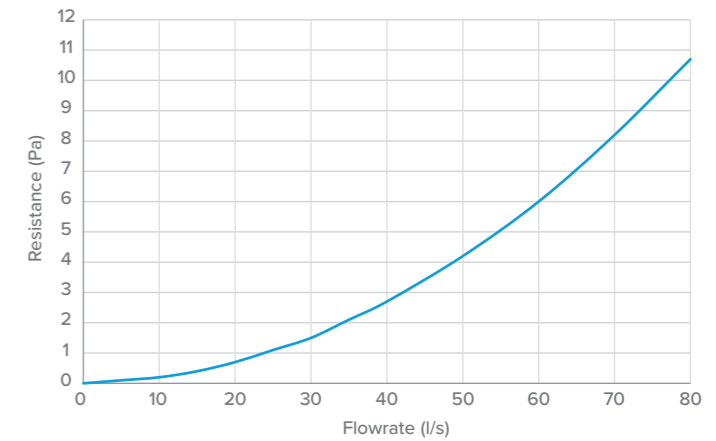
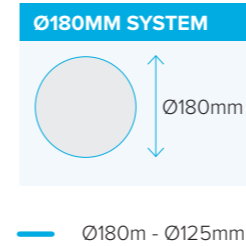

STEEL ROUND REDUCER Ø200MM - Ø125MM

CODE	DUCT SIZE		DESCRIPTION	CONNECTION	MATERIAL	COLOUR	FLAMMABILITY RATING	MANUFACTURED TO
	From	To						
RED200X125	Ø200mm	Ø125mm	In-line round steel duct reducer	Male	Steel	Steel	-	ISO9001



PART NUMBER	DUCT SIZE		RESISTANCE IN Pa												
			5l/s	10l/s	15l/s	20l/s	25l/s	30l/s	35l/s	40l/s	50l/s	60l/s	70l/s	80l/s	
RED200X125	From	To	0.1	0.2	0.4	0.6	0.9	1.3	1.7	2.2	3.5	5.0	6.8	8.9	
	Ø200mm	Ø125mm													

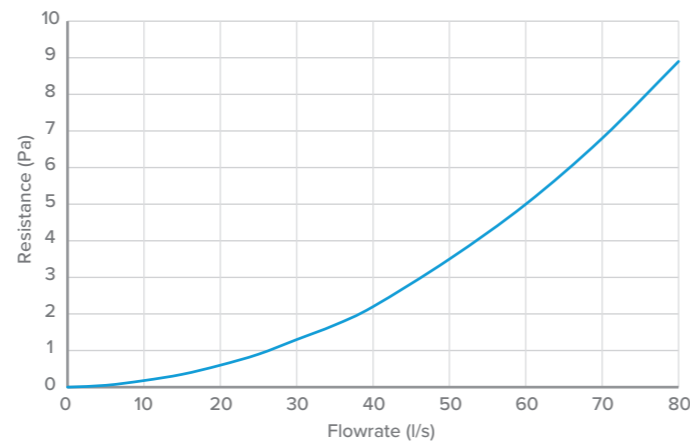
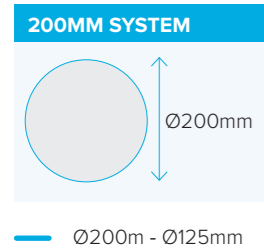

STEEL ROUND REDUCER Ø150MM - Ø125MM

CODE	DUCT SIZE		DESCRIPTION	CONNECTION	MATERIAL	COLOUR	FLAMMABILITY RATING	MANUFACTURED TO
	From	To						
RED150X125	Ø150mm	Ø125mm	In-line round steel duct reducer	Male	Steel	Steel	-	ISO9001



PART NUMBER	DUCT SIZE		RESISTANCE IN Pa												
			5l/s	10l/s	15l/s	20l/s	25l/s	30l/s	35l/s	40l/s	50l/s	60l/s	70l/s	80l/s	
RED150X125	From	To	0.1	0.2	0.5	0.9	1.4	2.0	2.7	3.5	5.4	7.7	10.3	13.2	
	Ø150mm	Ø125mm													

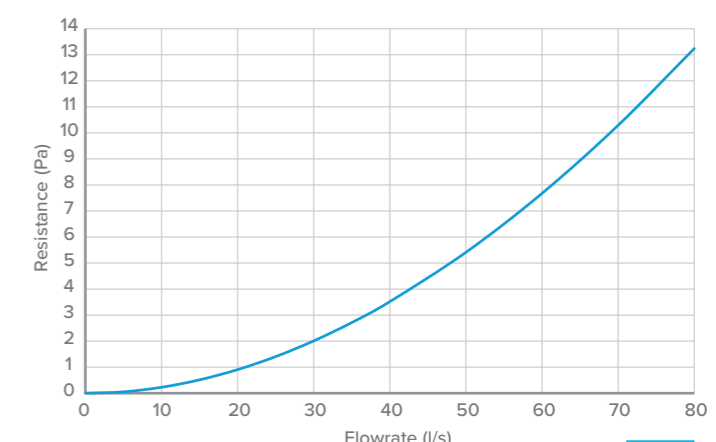
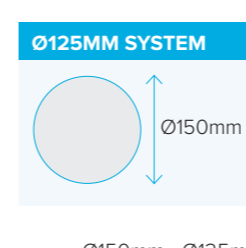

STEEL ROUND REDUCER Ø125MM - Ø100MM

CODE	DUCT SIZE		DESCRIPTION	CONNECTION	MATERIAL	COLOUR	FLAMMABILITY RATING	MANUFACTURED TO
RED125X100	From	To	In-line round steel duct reducer	Male	Steel	Steel	-	ISO9001
	Ø125mm	Ø100mm						



PART NUMBER	DUCT SIZE		RESISTANCE IN Pa												
			5l/s	10l/s	15l/s	20l/s	25l/s	30l/s	35l/s	40l/s	50l/s	60l/s	70l/s	80l/s	
RED125X100	From	To	0.1	0.7	1.6	2.9	4.6	6.7	9.1	11.8	18.2	25.6	33.9	43.0	
	Ø125mm	Ø100mm													

Ø125MM SYSTEM

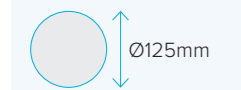

— Ø125mm - Ø100mm

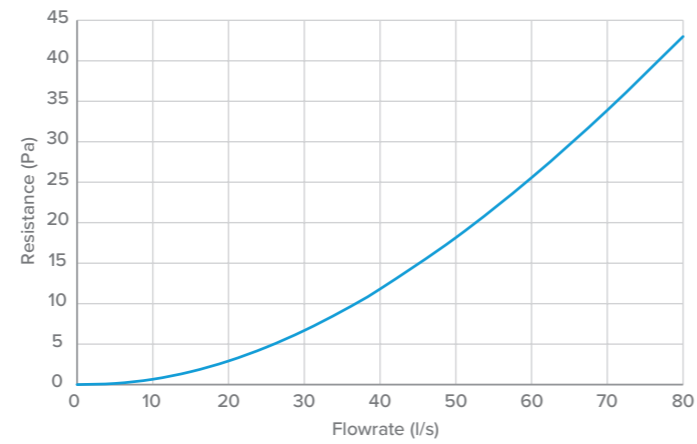

IN-LINE ADAPTER, RECTANGULAR TO ROUND 220X90MM - Ø150MM

CODE	AIR DIRECTION		DESCRIPTION	CONNECTION	MATERIAL	COLOUR	FLAMMABILITY RATING	MANUFACTURED TO
PVC970WH	From	To	In-line adapter rectangular to round	Female / Female	PVC	White	UL94HB	ISO9001
	220mm x 90mm	Ø150mm						



PART NUMBER	AIR DIRECTION	RESISTANCE IN Pa												
		5l/s	10l/s	15l/s	20l/s	25l/s	30l/s	35l/s	40l/s	50l/s	60l/s	70l/s	80l/s	
PVC970WH	Rect to Round	0.0	0.1	0.2	0.3	0.4	0.6	0.8	1.1	1.7	2.4	3.4	4.5	
	Round to Rect	0.0	0.1	0.1	0.1	0.2	0.2	0.3	0.4	0.6	0.8	1.1	1.5	

220MM X 90MM SYSTEM

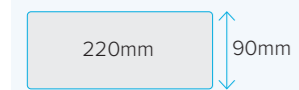

— 220x90mm Rect to Round
— 220x90mm Round to Rect

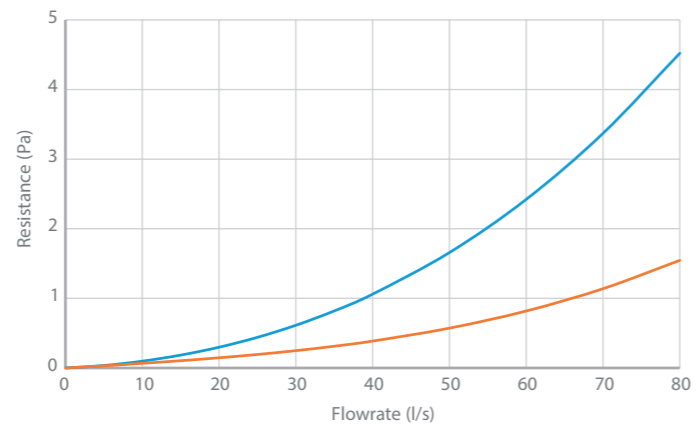

IN-LINE ADAPTER, RECTANGULAR TO ROUND 204X60MM - Ø125MM

CODE	AIR DIRECTION		DESCRIPTION	CONNECTION	MATERIAL	COLOUR	FLAMMABILITY RATING	MANUFACTURED TO
PVC570WH	From	To	In-line adapter rectangular to round	Female / Female	PVC	White	UL94HB	ISO9001
	204mm x 60mm	Ø125mm						



PART NUMBER	AIR DIRECTION	RESISTANCE IN Pa													
		5l/s	10l/s	15l/s	20l/s	25l/s	30l/s	35l/s	40l/s	50l/s	60l/s	70l/s	80l/s		
PVC570WH	Rect to Round	0.2	0.4	0.7	1.0	1.4	2.0	2.6	3.3	5.1	7.5	10.6	14.3		

204MM X 60MM SYSTEM

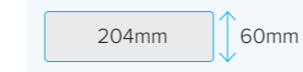

— 204x60m Rect to Round

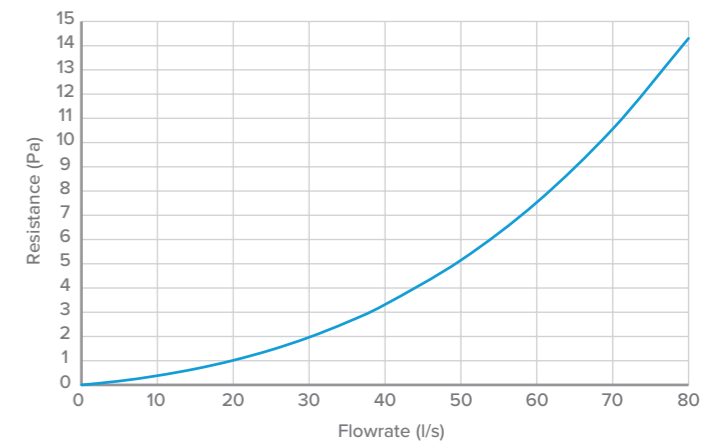

IN-LINE ADAPTER, RECTANGULAR TO ROUND 204X60MM - Ø100MM

CODE	AIR DIRECTION		DESCRIPTION	CONNECTION	MATERIAL	COLOUR	FLAMMABILITY RATING	MANUFACTURED TO
PVC073WH	From	To	In-line adapter rectangular to round	Duct / Male	PVC	White	UL94HB	ISO9001
	204mm x 60mm*	Ø100mm						



* To Single Air brick

PART NUMBER	AIR DIRECTION	RESISTANCE IN Pa							
		5l/s	10l/s	15l/s	20l/s	25l/s	30l/s	35l/s	40l/s
PVC073WH	Rect to Round	0.5	2.2	4.8	8.6	13.4	19.2	26.1	33.9
	Round to Rect	0.3	1.1	2.4	4.3	6.8	9.8	13.5	17.7

204MM X 60MM SYSTEM

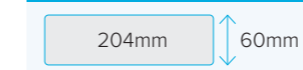

— 204x60mm Rect to Round
— 204x60mm Round to Rect

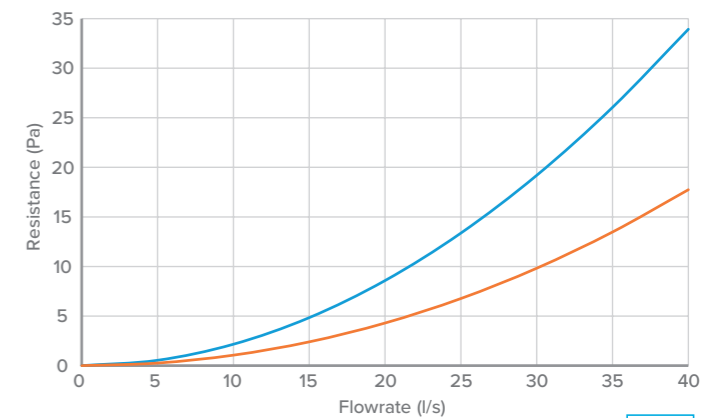

IN-LINE ADAPTER, RECTANGULAR TO ROUND 121X60MM - Ø100MM

CODE	AIR DIRECTION		DESCRIPTION	CONNECTION	MATERIAL	COLOUR	FLAMMABILITY RATING	MANUFACTURED TO
	From	To						
PVC470WH	121mm x 60mm	Ø100mm	In-line adapter rectangular to round	Female / Female	HIPS (High Impact Polystyrene)	White	UL94V0	ISO9001



PART NUMBER	AIR DIRECTION	RESISTANCE IN Pa							
		5l/s	10l/s	15l/s	20l/s	25l/s	30l/s	35l/s	40l/s
PVC470WH	Rect to Round	0.2	0.6	1.3	2.4	3.8	5.4	7.4	9.6

121MM X 60MM SYSTEM

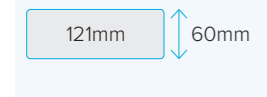

121x60mm Rect to Round

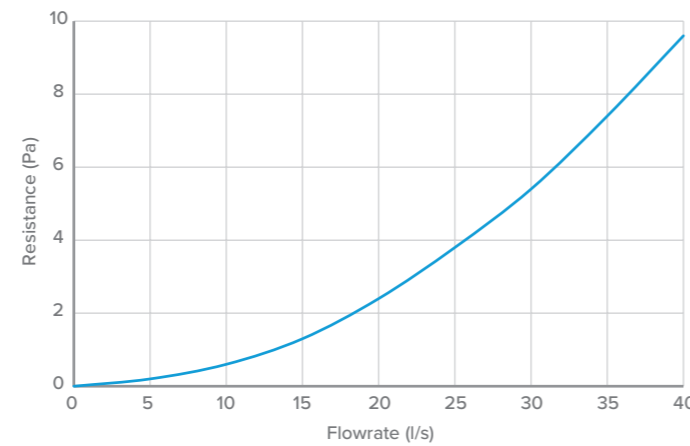

IN-LINE ADAPTER, RECTANGULAR TO ROUND 110X54MM - Ø100MM

CODE	AIR DIRECTION		DESCRIPTION	CONNECTION	MATERIAL	COLOUR	FLAMMABILITY RATING	MANUFACTURED TO
	From	To						
PVC070WH	110mm x 54mm	Ø100mm	In-line adapter rectangular to round	Female / Duct	PVC	White	UL94HB	ISO9001



PART NUMBER	AIR DIRECTION		RESISTANCE IN Pa							
	From	To	5l/s	10l/s	15l/s	20l/s	25l/s	30l/s	35l/s	40l/s
PVC070WH	110mm x 54mm	Ø100mm	0.3	1.3	2.9	5.2	8.1	11.6	15.8	20.6
	Ø100mm	110mm x 54mm								

110MM X 54MM SYSTEM

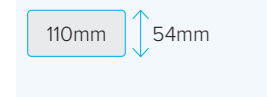

110x54mm Rect to Round
110x54mm Round to Rect

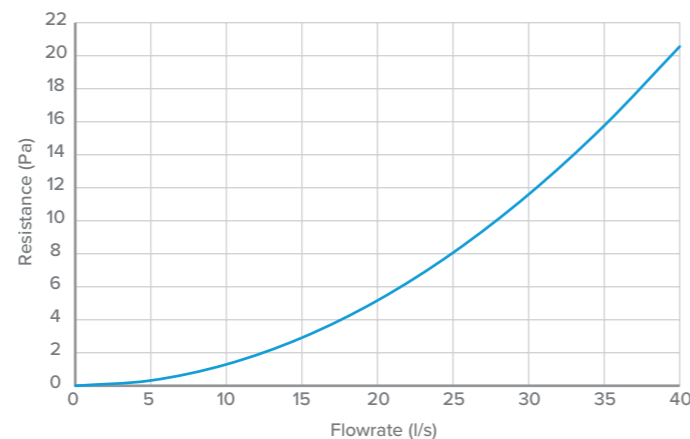

FLEXIBLE DUCTING

RECTANGULAR FLEXIBLE PVC HOSE

220MM X 90MM SYSTEM	204MM X 60MM SYSTEM	110MM X 54MM SYSTEM
220mm x 90mm	204mm x 60mm	110mm x 54mm



CODE	DIAMETER RANGE (MM) (INTERNAL)	DESCRIPTION	MATERIAL	TEMPERATURE RANGE (°C)	PACKING	CLAMPING
PVC933WH	220mm x 90mm	Rectangular flexible hose 3m length	White PVC 70µm thick	-20/+60 working (80 max.)	Compressed individually in net sleeve	D-TIE nylon zip-tie
PVC592WH	204mm x 60mm	Rectangular flexible hose 3m length	White PVC 70µm thick	20/+60 working (80 max.)	Compressed individually in net sleeve	D-TIE nylon zip-tie
PVC492WH	110mm x 54mm	Rectangular flexible hose 3m length	White PVC 70µm thick	20/+60 working (80 max.)	Compressed individually in net sleeve	D-TIE nylon zip-tie

ROUND FLEXIBLE PVC HOSE

CODE	DIAMETER RANGE (MM) (INTERNAL)	DESCRIPTION	MATERIAL	TEMPERATURE RANGE (°C)	MAX. AIR VELOCITY	MAX. POSITIVE WORKING PRESSURE	PACKING
PVC363WH	Ø100mm	PVC flexible hose 3m length	White PVC 70µm thick	-20/+60 working (80 max.)	30m/sec	3000 Pa	Compresses individually in net sleeve



Ø100MM SYSTEM



OVERVIEW	CONSTRUCTION
<p>Range of wire reinforced, flexible PVC ducting that has been specially designed for the ventilation market. The hose provides solutions to overcome situations where rigid components cannot be installed.</p> <p>Flexible hose is particularly suitable for installation where there is slow moving air, such as the ducting of tumble driers.</p>	<p>Flexible hose is constructed as a continuous left-hand helix (English wound) on a bespoke forming "head". The reinforcing wire is 100% sealed inside a fold of PVC tape which is in turn overlapped by the next pitch. The joints are welded by hot air welding of the layers of PVC in order to provide a continuous sealed tube.</p>

ROUND FLEXIBLE ALUMINIUM HOSE

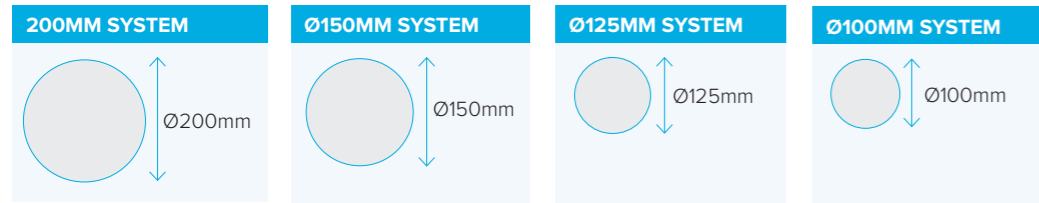

CODE	DIAMETER RANGE (MM) (INTERNAL)	DESCRIPTION	MATERIAL
FLD200	Ø200mm	Round flexible hose 5m length	Aluminium
FLD150	Ø150mm	Round flexible hose 5m length	Aluminium
FLD125	Ø125mm	Round flexible hose 5m length	Aluminium
FLD100	Ø100mm	Round flexible hose 5m length	Aluminium

OVERVIEW

For years the designer's need for a fire resistant flexible duct has been hampered by the lack of flexibility and fragile nature of metallic ducting. Nuair Aluminium Flexible Duct overcomes these problems.

Aluminium Flexible Duct is a corrugated flexible ducting, which can be formed to bend radii less than 1/2D. It is supplied in its compressed state but when installed the tube extends to 5 metres for maximum flexibility and economy – making it the simple answer to many flexible duct problems.

FLEXIBLE

The extra deep corrugations of Aluminium Flexible Duct bring a new flexibility to metal tube. It comes in all diameters from 75mm to 315mm and may be hand-formed to bends of less than a 1/2D Radius – a feature previously only thought possible with fabric flexibles.

Aluminium Flexible Duct can also be extended or compressed easily for installation between spigots located opposite to each other. It is ideal for final connections or where space is limited.

STRONG

Strength and pliability in metal flexibles are affected by the thickness, corrugation shape and ductility of the material used in construction. In the past a strong tube has lacked flexibility and flexible tube has lacked strength.

With Aluminium Flexible Duct the problems are overcome by producing a deep corrugation tube, which is kept in the compressed state until it is installed; in this state it has great strength with little flexibility.

At the time of installation, when strength is a lower priority, the tube is extended to achieve its ultimate in flexibility.

FIRE RESISTING

Aluminium Flexible Duct is tested to BS476 Part 6, 7 and 8, and meets the requirements for CP413 section A2.2.3 (Ducts for Building Services) and is suitable for use throughout the U.K. and the Continent. When tested to BS476 Part 7 a class 1 spread of flame was recorded. When tested under the conditions laid down in BS476 Part 8 Aluminium Flexible Duct maintained its integrity for 15 minutes. As it is of all metal construction smoke generation is negligible.

SELF SUPPORTING

Aluminium Flexible Duct retains its corrugation form in use and in doing so achieves maximum distance between supports without sagging, resulting in cost savings in labour and materials when compared to fabric flexible.

It also retains its cross section regardless of its state; it can be compressed, extended, or formed into bends or offsets with no reduction in area. This means that frictional resistance figures are constant and air flow figures can be accurately predicted at the design stage.

The tube is stable after forming with no tendency to spring back, thus forces on spigots are kept to the very minimum.

ROUND ACOUSTIC FLEXIBLE HOSE

CODE	DIAMETER RANGE MM INTERNAL	DESCRIPTION
SRDI200	Ø200mm	Acoustic flexible hose 3m length
SRDI150	Ø150mm	Acoustic flexible hose 3m length
SRDI125	Ø125mm	Acoustic flexible hose 3m length
SRDI100	Ø100mm	Acoustic flexible hose 3m length

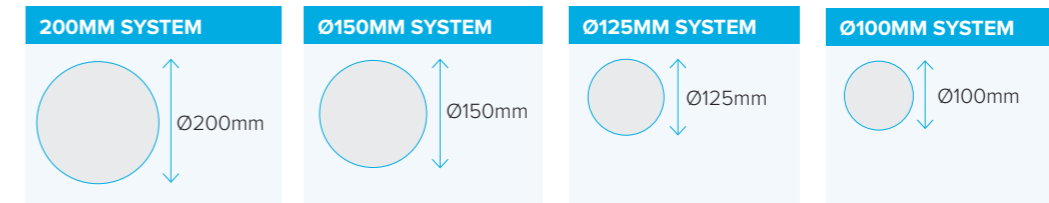

OVERVIEW

A perforated, bendable aluminium duct covered with an external layer of mineral wool, offering a high level of both thermal and acoustic insulation.

Suitable for both large and small installation, acoustic flexible ducting's semi-rigid characteristics allow complete systems to be installed in acoustic ductwork. It's "stay put" ability ensures straight air paths that will not sag between supports, whilst it's flexibility allows bends and offsets around obstructions.

CONSTRUCTION

Supplied in 3m lengths.

INNER TUBE

Laminated aluminium corrugated semi-rigid tube with a perforation area of 25%.

INSULATION

Acoustic density mineral wool faced with woven glass fibre which prevents the erosion of the insulation material in high velocity applications, keeping fibres out of the air stream.

OUTER CASINGS

Fibre glass scrim reinforced aluminium-faced polyester seamless sleeve acting as both vapour barrier and air retaining tube. Aluminium/polyester has a fire resistance of Class 1 to BS476 Part 7 (Nil spread of flame).

ROUND INSULATED FLEXIBLE HOSE

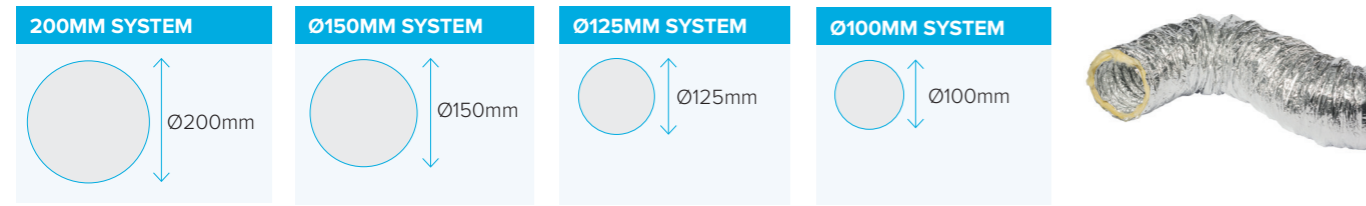

CODE	DIAMETER RANGE (MM) (INTERNAL)	DESCRIPTION	TEMPERATURE RANGE (°C)	MAX. AIR VELOCITY	MAX. POSITIVE WORKING PRESSURE	PACKING
FLDI200	Ø200mm	Aluminium insulated flexible hose 5m length	-30/+150	30m/sec	3000 Pa	Individual box compressed to 1m
FLDI150	Ø150mm	Aluminium insulated flexible hose 5m length	-30/+150	30m/sec	3000 Pa	Individual box compressed to 1m
FLDI125	Ø125mm	Aluminium insulated flexible hose 5m length	-30/+150	30m/sec	3000 Pa	Individual box compressed to 1m
FLDI100	Ø100mm	Aluminium insulated flexible hose 5m length	-30/+150	30m/sec	3000 Pa	Individual box compressed to 1m

OVERVIEW

Range of wire reinforced, flexible PVC ducting that has been specially designed for the ventilation market.

The hose provides solutions to overcome situations where rigid components cannot be installed.

Flexible hose is particularly suitable for installation where there is slow moving air, such as the ducting of tumble driers.

CONSTRUCTION

Insulated flexible hose is produced from multi-layer aluminium and metallized polymer, strengthened with high tension hard steel spring wire, surrounded with glass wool insulated and an aluminium vapour barrier.

GRILLES & DIFFUSERS

STEEL SUPPLY AIR VALVE

Ø125MM SYSTEM	CODE	DUCT SIZE	DESCRIPTION	COLOUR
	VS125-V	Ø125mm	Steel supply air valve	White



PART NUMBER	DUCT SIZE	RESISTANCE IN Pa											
		5l/s	10l/s	15l/s	20l/s	25l/s	30l/s	35l/s	40l/s	50l/s	60l/s	70l/s	80l/s
VS125-V	Ø125mm	2.6	6.1	11.8	19.8	30.1	42.9	58.1	75.9	119.5	174.2	240.7	319.5

Resistances based at 10mm opening

For the use of all PVC terminations please refer to Approved document B Volume 1 2019 edition in the UK and Building Standards Technical Handbook 2019 in Scotland or

alternatively seek guidance from your local authority building control officer/fire specialist.

OVERVIEW

The VS125-V Ø125mm diameter round white metal ceiling air supply valve is manufactured from white epoxy powder coated steel. The valve has a male spigot to fit inside of a Ø125mm duct.

The valve is fully adjustable and has a locking nut to fix the position of the control disc upon commissioning.

The valve is supplied complete with a fixing body with pre-drilled holes for installation.

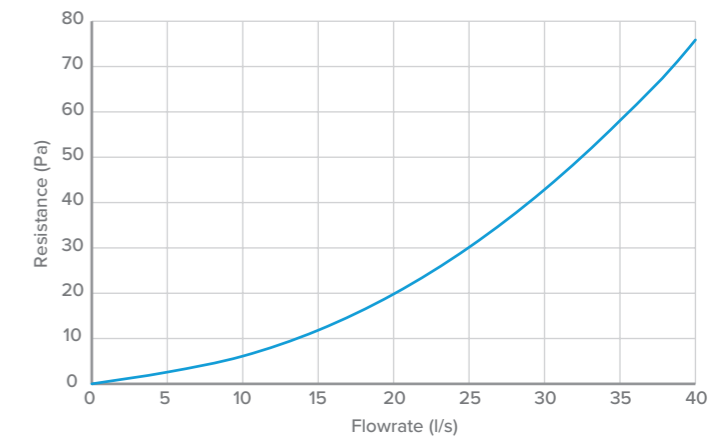

BACK VIEW (FIXING BODY)

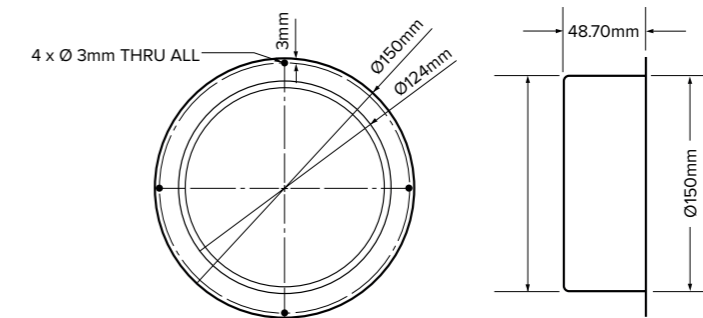

FRONT VIEW (CEILING VALVE)

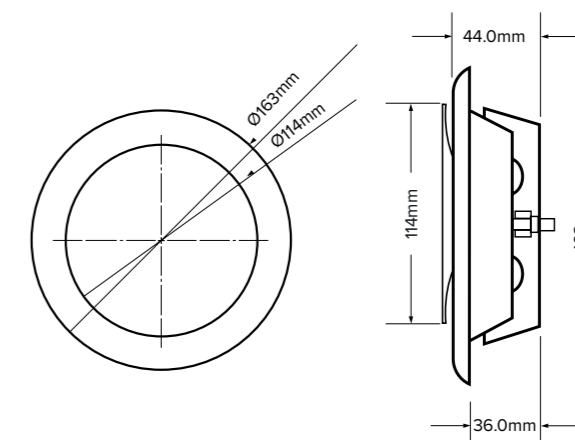

LOUVERED GRILLE WITH FLYSCREEN

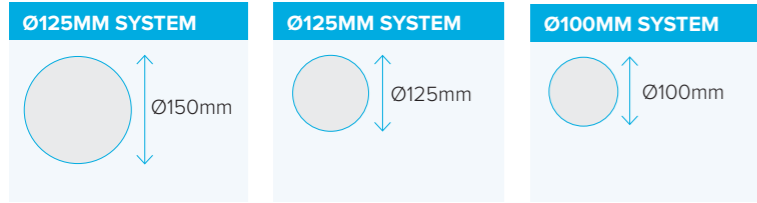

CODE	AIR DIRECTION	DESCRIPTION	CONNECTION	MATERIAL	COLOUR	FLAMMABILITY RATING	MANUFACTURED TO
PVC604WH	Ø150mm	Fixed louvre grille with flyscreen	Male	HIPS (High Impact Polystyrene)	White	UL94V0	ISO9001
PVC504WH	Ø125mm	Fixed louvre grille with flyscreen	Male	HIPS (High Impact Polystyrene)	White	UL94V0	ISO9001
PVC104WH	Ø100mm	Fixed louvre grille with flyscreen	Male	HIPS (High Impact Polystyrene)	White	UL94V0	ISO9001

PART NUMBER	AIR DIRECTION	RESISTANCE IN Pa											
		5l/s	10l/s	15l/s	20l/s	25l/s	30l/s	35l/s	40l/s	50l/s	60l/s	70l/s	80l/s
PVC604WH	Intake (A) - Ø150mm	0.9	2.4	4.3	6.9	10.0	13.8	18.4	23.6	36.5	52.9	73.0	97.3
	Exhaust (A) - Ø150mm	0.76	1.83	3.26	5.07	7.31	10.00	13.19	16.91	25.49	37.09	51.52	69.07

Ø150MM SYSTEM

— Intake (A) - Ø150mm
— Exhaust (A) - Ø150mm

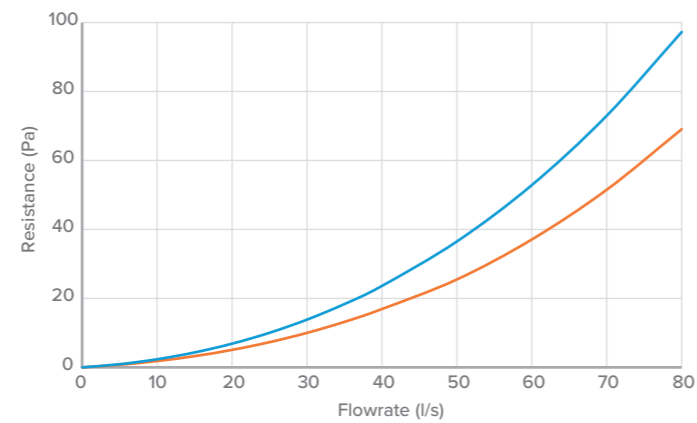

PART NUMBER	AIR DIRECTION	RESISTANCE IN Pa											
		5l/s	10l/s	15l/s	20l/s	25l/s	30l/s	35l/s	40l/s	50l/s	60l/s	70l/s	80l/s
PVC504WH	Intake (A) - Ø125mm	1.2	3.3	6.2	9.9	14.5	20.2	26.9	34.7	53.9	78.4	108.6	145.2
	Exhaust (A) - Ø125mm	1.1	2.7	4.8	7.4	10.6	14.5	19.0	24.3	37.4	54.2	75.1	100.6

Ø125MM SYSTEM

— Intake (A) - Ø125mm
— Exhaust (A) - Ø125mm

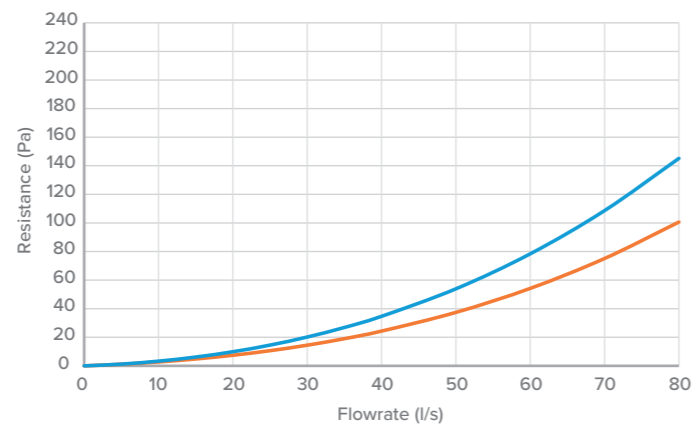

PART NUMBER	AIR DIRECTION	RESISTANCE IN Pa											
		5l/s	10l/s	15l/s	20l/s	25l/s	30l/s	35l/s	40l/s	50l/s	60l/s	70l/s	80l/s
PVC104WH	Intake (A) - Ø100mm	2.3	6.4	12.2	19.9	29.4	40.8	54.3	69.7	106.8	152.7	207.6	271.9
	Exhaust (A) - Ø100mm	1.9	4.7	8.3	13.0	18.6	25.3	33.2	42.3	64.4	92.1	125.9	166.2

Ø125MM SYSTEM

— Intake (A) - 100mm
— Exhaust (A) - Ø100mm

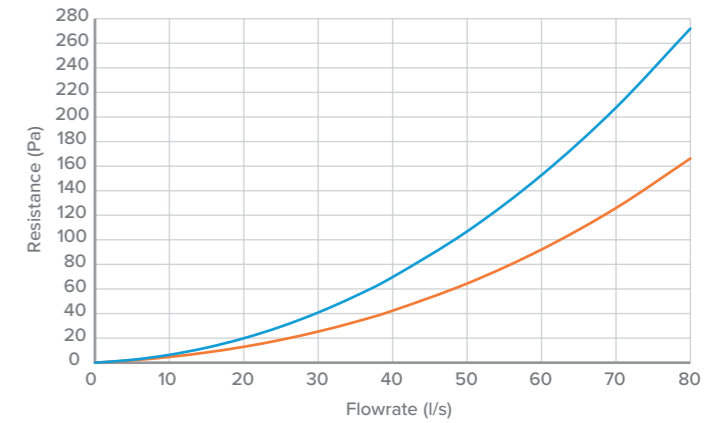

LOUVERED GRILLE WITHOUT FLYSCREEN

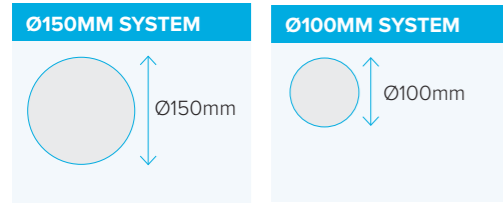

CODE	DUCT SIZE	DESCRIPTION	CONNECTION	MATERIAL	COLOUR	FLAMMABILITY RATING	MANUFACTURED TO
PVC604LR	Ø150mm	Fixed louvre grille without flyscreen	Male	HIPS (High Impact Polystyrene)	White	UL94V0	ISO9001
PVC104LR	Ø100mm	Fixed louvre grille without flyscreen	Male	HIPS (High Impact Polystyrene)	White	UL94V0	ISO9001

PART NUMBER	DUCT SIZE	RESISTANCE IN Pa											
		5l/s	10l/s	15l/s	20l/s	25l/s	30l/s	35l/s	40l/s	50l/s	60l/s	70l/s	80l/s
PVC604LR	Intake (A) - Ø150mm	0.2	0.6	1.3	2.2	3.4	4.9	6.6	8.7	13.5	19.5	26.7	35.0
	Exhaust (A) - Ø150mm	0.1	0.2	0.4	0.7	1.1	1.5	2.0	2.5	3.7	5.2	6.8	8.7

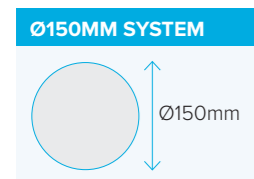

— Intake (A) - Ø150mm
— Exhaust (A) - Ø150mm

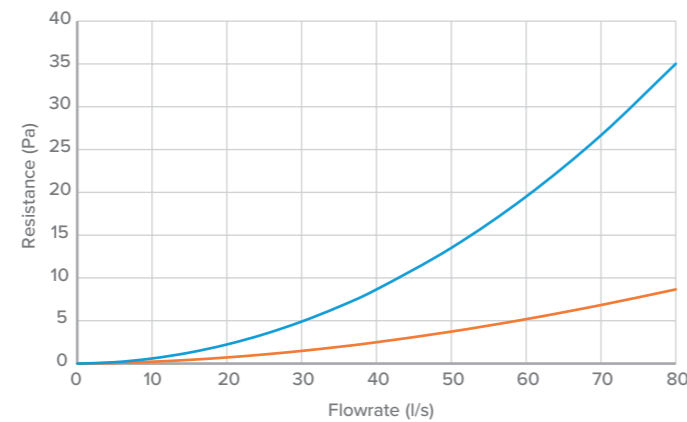

PART NUMBER	DUCT SIZE	RESISTANCE IN Pa											
		5l/s	10l/s	15l/s	20l/s	25l/s	30l/s	35l/s	40l/s	50l/s	60l/s	70l/s	80l/s
PVC504LR	Intake (A) - Ø150mm	0.1	0.7	1.6	2.9	4.7	6.8	9.4	12.5	19.9	29.2	40.6	54.1
	Exhaust (A) - Ø150mm	0.0	0.1	0.3	0.5	0.8	1.1	1.6	2.1	3.4	5.1	7.1	9.5

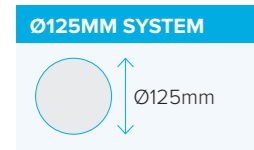

— Intake (A) - Ø125mm
— Exhaust (A) - Ø125mm

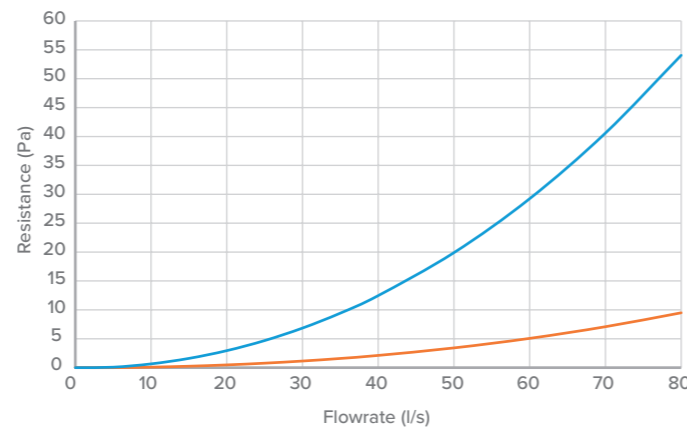

PART NUMBER	DUCT SIZE	RESISTANCE IN Pa											
		5l/s	10l/s	15l/s	20l/s	25l/s	30l/s	35l/s	40l/s	50l/s	60l/s	70l/s	80l/s
PVC104LR	Intake (A) - Ø100mm	0.6	2.4	5.3	9.4	14.5	20.7	28.0	36.3	56.0	79.4	106.4	136.7
	Exhaust (A) - Ø100mm	0.2	0.6	1.4	2.4	3.7	5.2	7.0	9.0	13.5	18.8	24.7	31.0

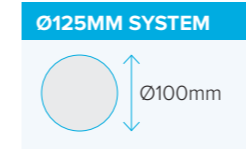

— Intake (A) - 100mm
— Exhaust (A) - Ø100mm

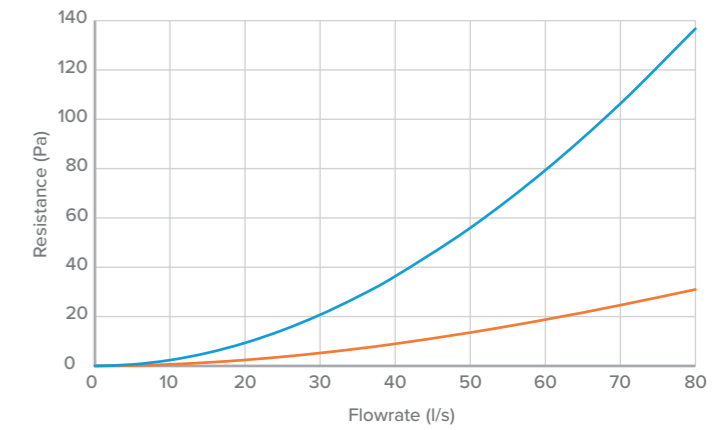

NON-COMBUSTIBLE METAL AIR BRICKS

Nuaire's range of metal air bricks are designed to meet the latest fire safety standards set out in Approved Document B, whilst ensuring a low resistance and unobtrusive installation.

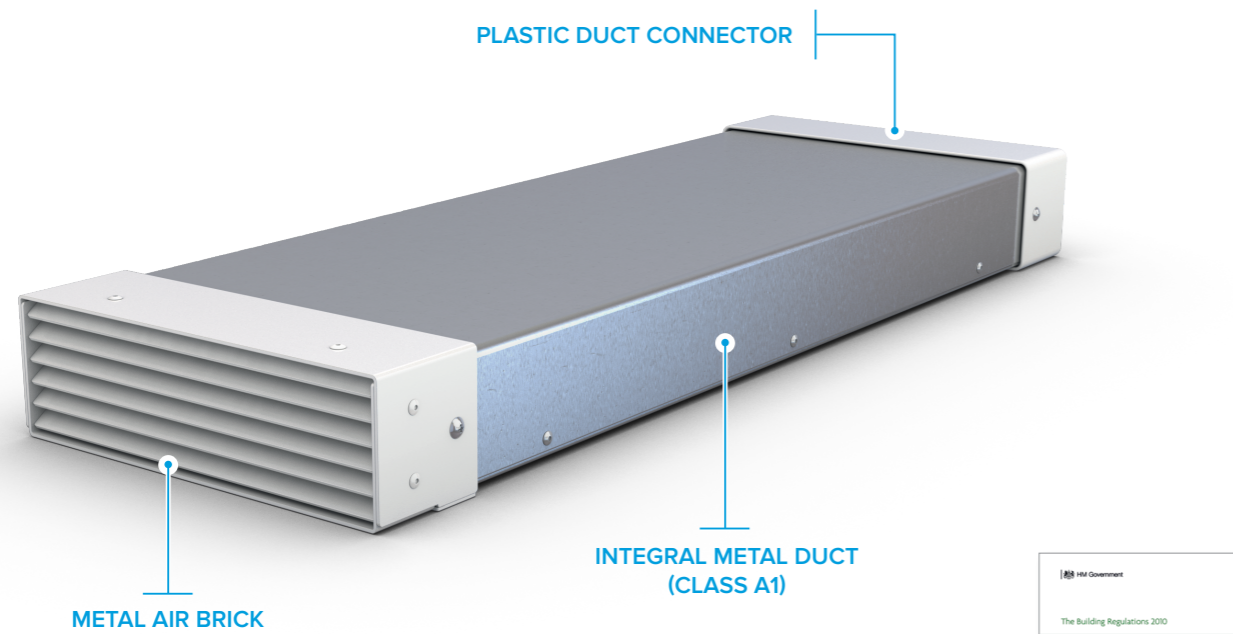
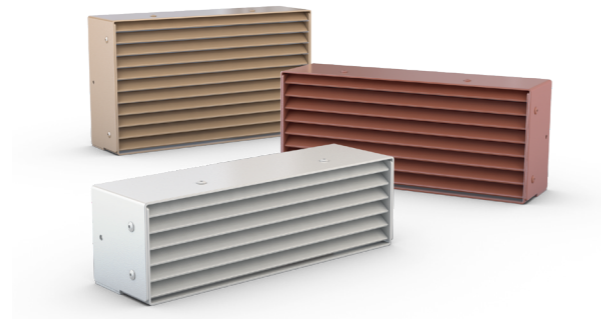

Developed to meet the requirements of Approved document B.



- 

NON-COMBUSTIBLE
Meets fire safety standards from Approved Document B.
- 

LOW RESISTANCE
Designed and tested to ensure the lowest possible system resistance.
- 

FULL RANGE
Available in 220x126, 220x90 and 204x60mm.
- 

SAFE CONSTRUCTION
Manufactured from 1.5mm galvanised steel, fire class A1 'no contribution to fire'.
- 

HIGH CLASSIFICATION
Powder coating pre-qualified to EN13501-1 classification A2-s1,d0.

METAL AIR BRICK SPECIFICATIONS & RESISTANCE DATA

MAB-220X126-WH

DUCT SIZE	DESCRIPTION	CONNECTION	MATERIAL	COLOUR	FLAMMABILITY RATING	MANUFACTURE STANDARD
220mm x 126mm	Non-combustible, low resistance metal air brick	Female	Galvanised steel	White	A2-s1; d0 (powder coating); A1 (base material)	ISO9001



PART NUMBER	DUCT SIZE	AIR DIRECTION	RESISTANCE IN Pa							
			10l/s	20l/s	30l/s	40l/s	50l/s	60l/s	70l/s	80l/s
MAB-220X126-WH	220mm x 126mm	Intake	0.7	2.6	5.5	9.7	15.0	21.4	29.0	37.8
		Exhaust	0.2	0.8	1.6	2.7	4.1	5.7	7.5	9.6

Supply Air (blue line)
Extract Air (orange line)

Note: Supply Data based on Test Report No. TB2327.
Exhaust Data based on Test Report No. TB2334.

Note: Performance testing carried out using BS EN 13141-2.

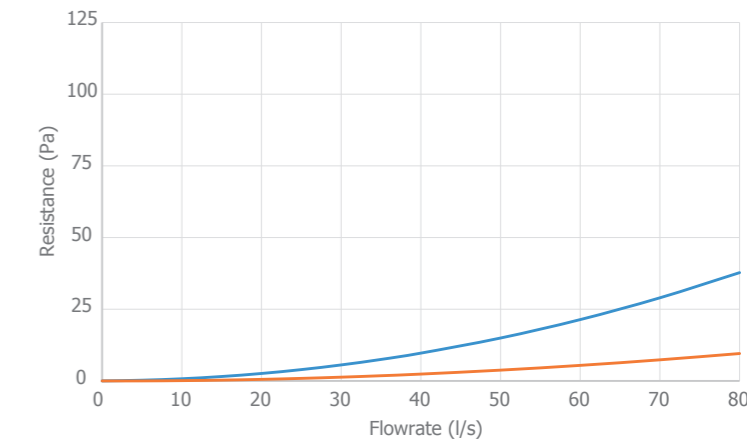

MAB-220X90-WH

DUCT SIZE	DESCRIPTION	CONNECTION	MATERIAL	COLOUR	FLAMMABILITY RATING	MANUFACTURE STANDARD
220mm x 90mm	Non-combustible, low resistance metal air brick	Female	Galvanised steel	White	A2-s1; d0 (powder coating); A1 (base material)	ISO9001



PART NUMBER	DUCT SIZE	AIR DIRECTION	RESISTANCE IN Pa							
			10l/s	20l/s	30l/s	40l/s	50l/s	60l/s	70l/s	80l/s
MAB-220X90-WH	220mm x 90mm	Intake	1.0	4.0	9.0	15.9	24.7	35.5	48.2	62.9
		Exhaust	1.1	2.3	4.1	6.5	9.5	13.0	17.1	21.9

Supply Air (blue line)
Extract Air (orange line)

Note: Supply Data based on Test Report No. TB2328.
Exhaust Data based on Test Report No. TB2333.

Note: Performance testing carried out using BS EN 13141-2.

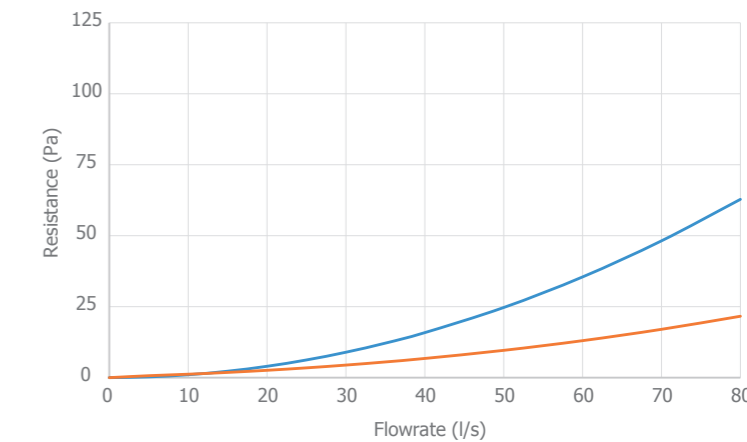

METAL AIR BRICK

SPECIFICATIONS & RESISTANCE DATA

MAB-204X60-WH

DUCT SIZE	DESCRIPTION	CONNECTION	MATERIAL	COLOUR	FLAMMABILITY RATING	MANUFACTURE STANDARD
204mm x 60mm	Non-combustible, low resistance metal air brick	Female	Galvanised steel	White	A2-s1; d0 (powder coating); A1 (base material)	ISO9001



PART NUMBER	DUCT SIZE	AIR DIRECTION	RESISTANCE IN Pa							
			10l/s	20l/s	30l/s	40l/s	50l/s	60l/s	70l/s	80l/s
MAB-204X60-WH	204mm x 60mm	Intake	2.1	7.7	16.9	29.8	46.3	66.4	90.1	117.5
		Exhaust	1.3	4.1	8.3	13.9	20.9	29.2	39.0	50.1

Supply Air
Extract Air

Note: Supply Data based on Test Report No. TB2329.
Exhaust Data based on Test Report No. TB2332.

Note: Performance testing carried out using BS EN 13141-2.

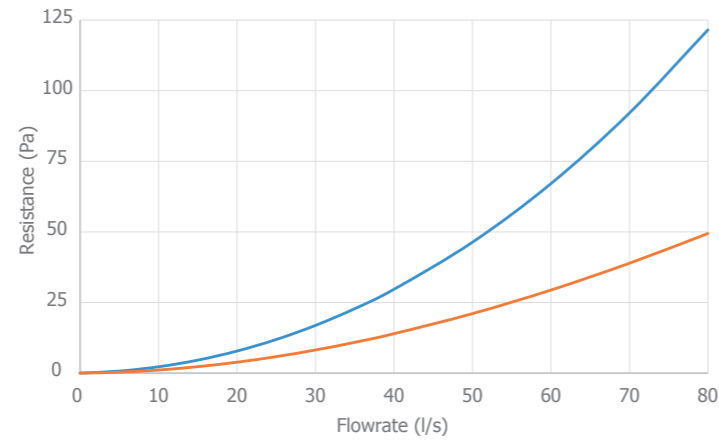

COLOUR OPTIONS

COLOUR	RAL REFERENCE	RAL TITLE	CODE SUFFIX
White	9016	Traffic White	WH
Brown	8011	Nut Brown	BR
Cotswold	1014	Ivory	COT
Terracotta	8004	Copper Brown	TC
Black	9017	Traffic Black	BK
Grey	7046	Telegrey 2	GREY

Nuair metal air bricks are available in multiple colours. Replace 'WH' on end of code with applicable suffix to change colour option. Colour options are applicable to metal air bricks only, not sleeves. For a bespoke colour, please contact Nuair on 029 2085 8500 or email residential.enquiries@nuair.co.uk.

INTEGRAL METAL DUCT (CLASS A1)

DIMENSIONS

For use with metal air bricks. Integral metal duct (Class A1) have **male** connections.

220X126

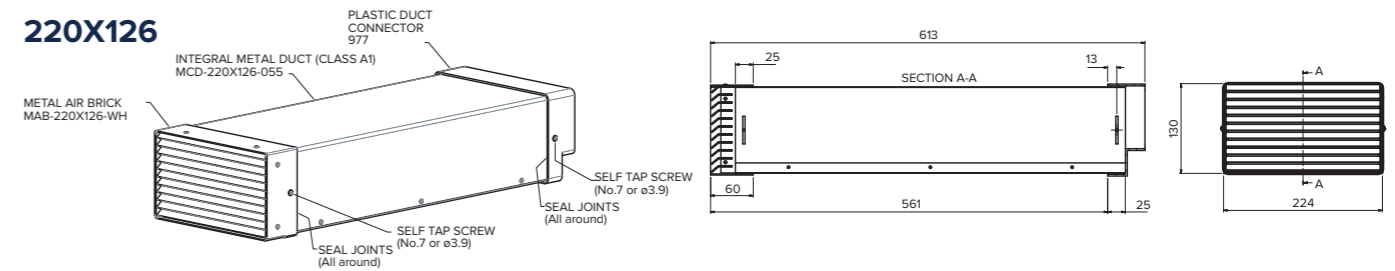

220X90

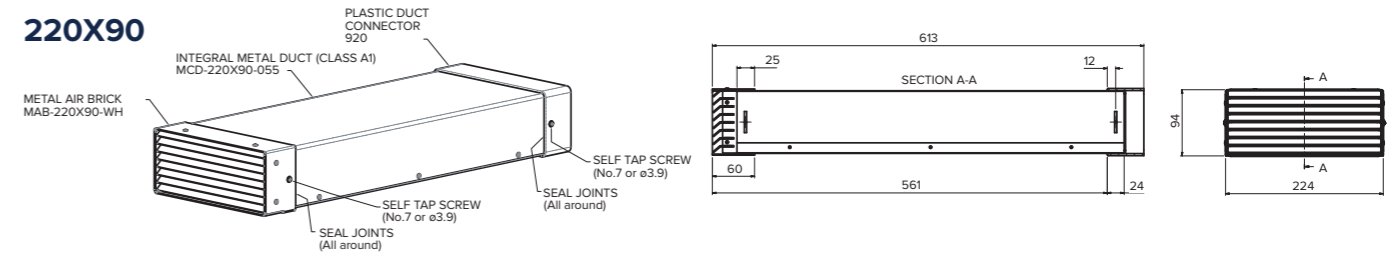

204X60

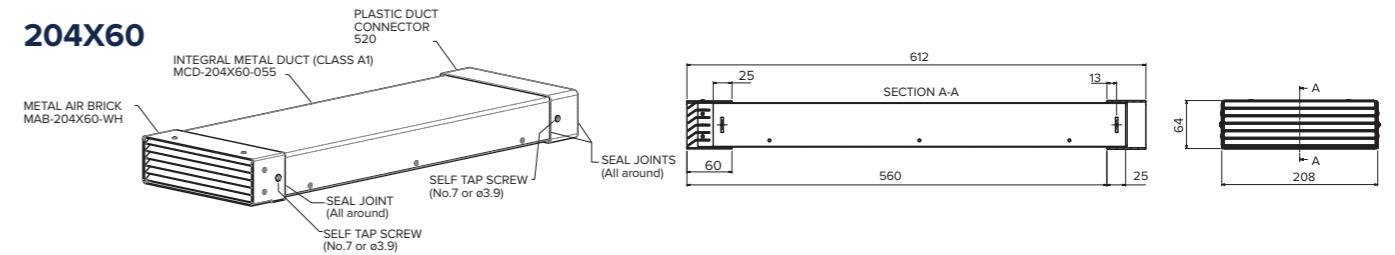

PVC AIR BRICK WITH SHUTTER

CODE	DUCT SIZE	DESCRIPTION	CONNECTION	MATERIAL	COLOUR	FLAMMABILITY RATING	MANUFACTURED TO
PVC501WH	204mm x 60mm	PVC air brick with shutter	Male	HIPS (High Impact Polystyrene)	White	UL94V0	ISO9001



PART NUMBER	DUCT SIZE	RESISTANCE IN Pa											
		5l/s	10l/s	15l/s	20l/s	25l/s	30l/s	35l/s	40l/s	50l/s	60l/s	70l/s	80l/s
PVC501WH	204mm x 60mm	10.2	19.1	28.5	38.3	48.6	59.7	71.5	84.3	112.8	146.1	184.9	230.2

204MM X 60MM SYSTEM

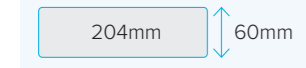

— 204x60mm

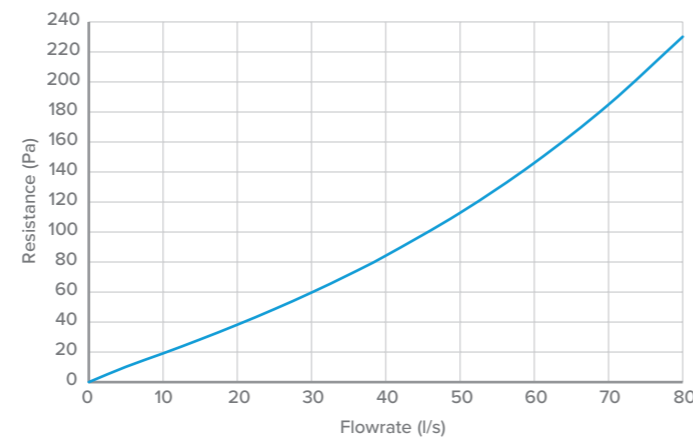

PVC AIR BRICK WITHOUT SHUTTER

CODE	DUCT SIZE	DESCRIPTION	CONNECTION	MATERIAL	COLOUR	FLAMMABILITY RATING	MANUFACTURED TO
PVC505NS	204mm x 60mm	PVC air brick without shutter	Male	HIPS (High Impact Polystyrene)	White	UL94V0	ISO9001



PART NUMBER	DUCT SIZE	RESISTANCE IN Pa											
		5l/s	10l/s	15l/s	20l/s	25l/s	30l/s	35l/s	40l/s	50l/s	60l/s	70l/s	80l/s
PVC505NS	Intake (A) - Rect to Round - 204mm x 60mm	0.6	3.2	7.5	13.6	21.4	31.1	42.4	55.5	86.9	125.2	170.2	222.1
	Exhaust (A) Round to Rect (A) - 204mm x 60mm	0.8	2.9	6.8	12.4	19.8	28.7	39.2	51.2	79.3	112.5	150.3	192.1

204MM X 60MM SYSTEM

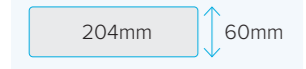

— Intake (A) 204x60mm
— Exhaust (A) 204x60mm

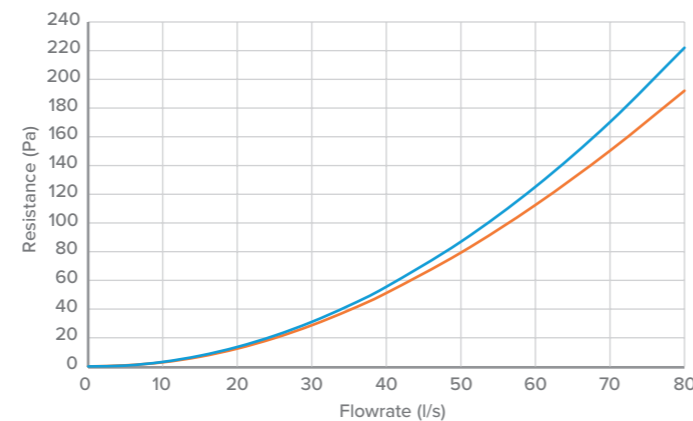

PVC DOUBLE AIR BRICK

CODE	DUCT SIZE	DESCRIPTION	CONNECTION	MATERIAL	COLOUR	FLAMMABILITY RATING	MANUFACTURED TO
PVC905WH-KIT	220mm x 90mm	PVC double air brick with adapter	Duct	Extruded uPVC	White	UL94V0	ISO9001



PART NUMBER	DUCT SIZE	RESISTANCE IN Pa											
		5l/s	10l/s	15l/s	20l/s	25l/s	30l/s	35l/s	40l/s	50l/s	60l/s	70l/s	80l/s
PVC905WH-KIT	Intake (A) Rect to Round - 220mm x 90mm	0.1	0.4	0.8	1.5	2.3	3.3	4.5	5.9	9.2	13.2	18.0	23.5
	Exhaust (A) Round to Rect (A) - 220mm x 90mm	0.0	0.1	0.3	0.5	0.7	1.0	1.4	1.8	2.8	4.0	5.5	7.3

220MM X 90MM SYSTEM

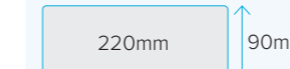

— Intake (A) 220x90mm
— Exhaust (A) 220x90mm

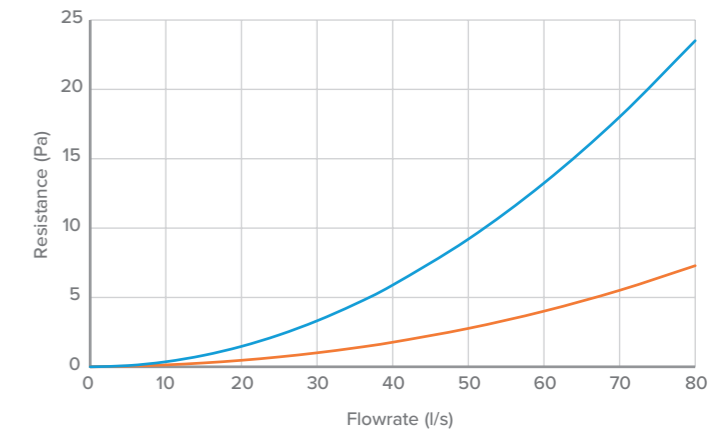

DOUBLE AIR BRICK DIMENSIONS (MM)

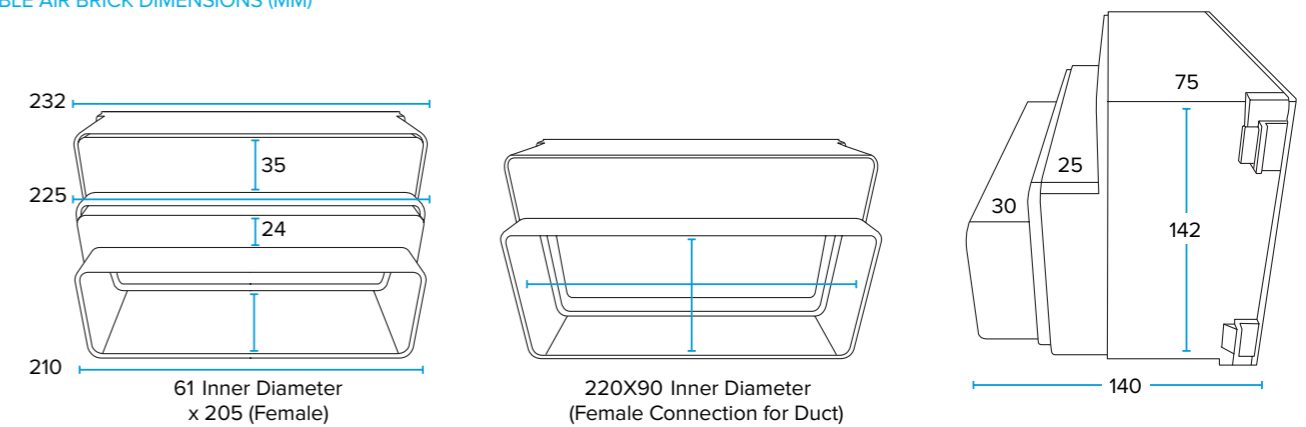

GRAVITY SHUTTER WALL OUTLET

CODE	DUCT SIZE	DESCRIPTION	CONNECTION	MATERIAL	COLOUR	FLAMMABILITY RATING	MANUFACTURED TO
PVC506WH	Ø125mm	Gravity flap wall outlet	Male	Polystyrene	White	UL94V0	ISO9001
PVC100WH	Ø100mm	Gravity flap wall outlet	Male	Polystyrene	Grey	UL94V0	ISO9001



PART NUMBER	DUCT SIZE	RESISTANCE IN Pa											
		5l/s	10l/s	15l/s	20l/s	25l/s	30l/s	35l/s	40l/s	50l/s	60l/s	70l/s	80l/s
PVC506WH	Ø125mm	2.3	4.2	5.8	7.1	8.2	9.1	9.8	10.4	11.1	11.5	11.9	12.4

Ø125MM SYSTEM

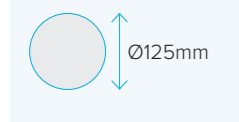

— Ø125mm

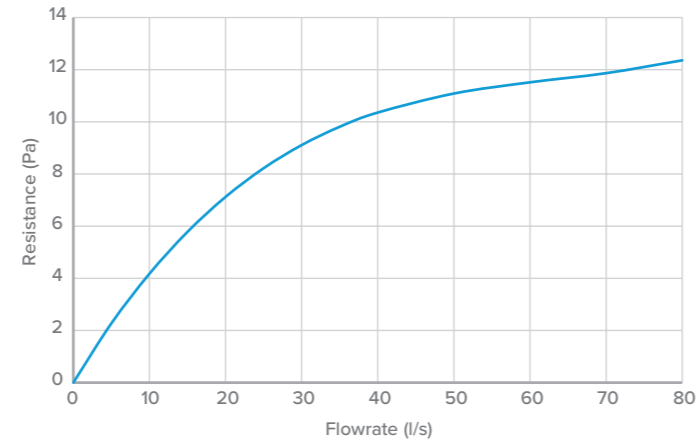

PART NUMBER	DUCT SIZE	RESISTANCE IN Pa											
		5l/s	10l/s	15l/s	20l/s	25l/s	30l/s	35l/s	40l/s	50l/s	60l/s	70l/s	80l/s
PVC100WH	Ø100mm	4.4	7.3	9.1	10.2	10.6	10.6	10.4	10.3	10.8	14.0	21.5	35.0

Ø100MM SYSTEM



— Ø100mm

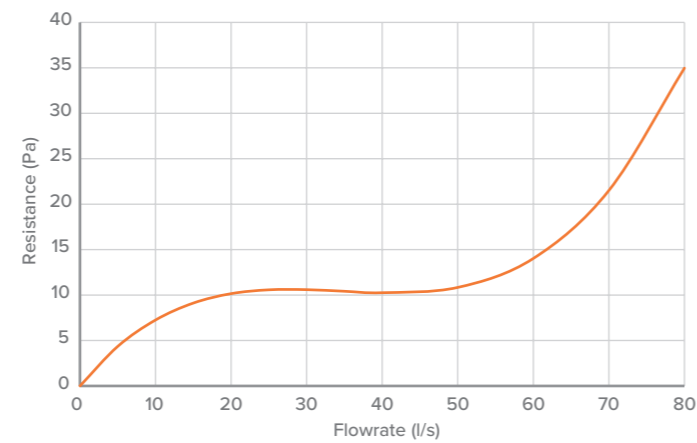

COWLED WALL OUTLET

CODE	DUCT SIZE	DESCRIPTION	CONNECTION	MATERIAL	COLOUR	FLAMMABILITY RATING	MANUFACTURED TO
PVC502WH	Ø125mm	Cowled outlet with gravity damper	Male	Polystyrene	White	UL94V0	ISO9001
PVC102WH	Ø100mm	Cowled outlet with gravity damper	Male	Polystyrene	Grey	UL94V0	ISO9001



PART NUMBER	DUCT SIZE	RESISTANCE IN Pa											
		5l/s	10l/s	15l/s	20l/s	25l/s	30l/s	35l/s	40l/s	50l/s	60l/s	70l/s	80l/s
PVC502WH	Ø125mm	2.0	3.4	4.5	5.4	6.2	6.9	7.6	8.4	10.3	13.1	17.3	23.4

Ø125MM SYSTEM

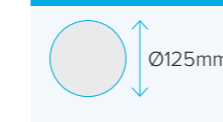

— Ø125mm

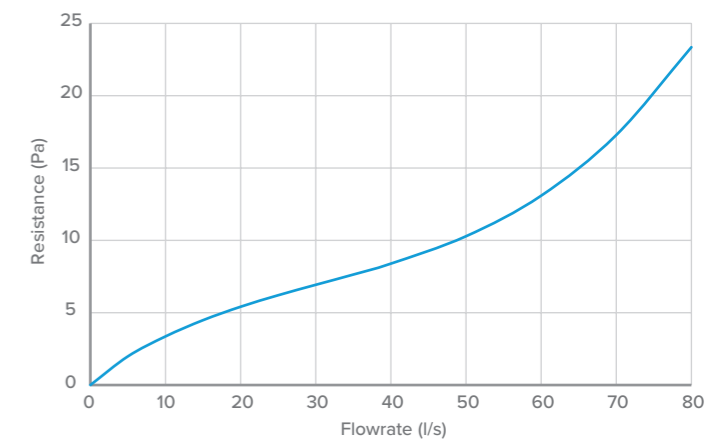

PART NUMBER	DUCT SIZE	RESISTANCE IN Pa											
		5l/s	10l/s	15l/s	20l/s	25l/s	30l/s	35l/s	40l/s	50l/s	60l/s	70l/s	80l/s
PVC102WH	Ø100mm	2.6	4.6	6.7	9.0	11.9	15.7	20.7	27.1	45.2	72.5	111.1	163.3

Ø100MM SYSTEM



— Ø100mm

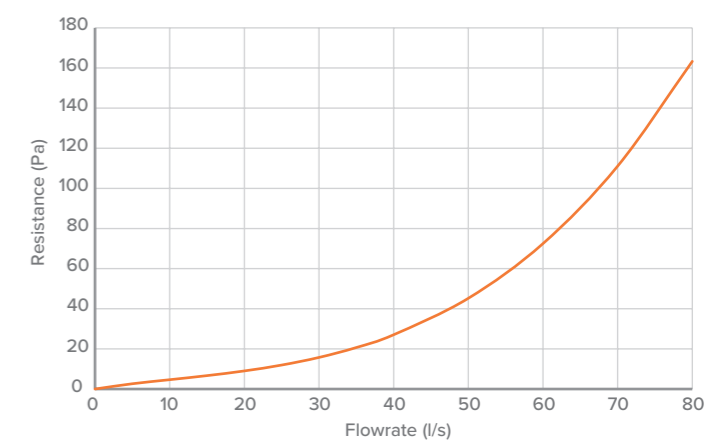

COWLS & TERMINALS

UNIVERSAL ROOF COWL

CODE	DUCT SIZE	DESCRIPTION	MATERIAL	COLOUR	WEIGHT
PVC4411	Ø100mm	Universal hooded tile roof terminal	PVC-U and Ubiflex	Anthracite/black skirt	1.53kg
PVC4411T	Ø100mm	Universal hooded tile roof terminal	PVC-U and Ubiflex	Terracotta/terracotta skirt	1.53kg



PRODUCT FEATURES

- 20,000mm² large free vent area
- Large diameter spigot with adaptor to accept ducting of 100/110/125/150/160mm

APPLICATION

- Mechanical extraction and intake
- Minimum pitch of 22.5°

DIMENSIONS

- 500mm x 500mm skirt
- Stepped adaptor – H: 215mm

PART NUMBER	DUCT SIZE	RESISTANCE IN Pa											
		5l/s	10l/s	15l/s	20l/s	25l/s	30l/s	35l/s	40l/s	50l/s	60l/s	70l/s	80l/s
PVC4411	Ø100mm	0.1	0.4	1.2	2.5	4.1	6.1	8.4	11.1	17.6	25.5	34.6	45.0
PVC4411T													

Ø100MM SYSTEM



— Ø100mm

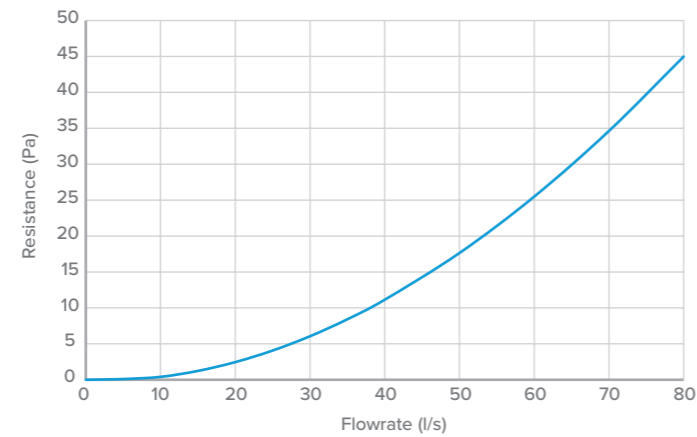

PITCHED ROOF TERMINAL

CODE	DUCT SIZE	DESCRIPTION	MATERIAL	COLOUR	MANUFACTURED TO
PVCTT9-BROWN	Ø125mm Geometric Free area 12,270mm ²	Pitched roof tile plate terminal	ABS	Brown	BS EN ISO9001
PVCTT9-GREY		Pitched roof tile plate terminal	ABS	Grey	BS EN ISO9001
PVCTT9-RED		Pitched roof tile plate terminal	ABS	Red	BS EN ISO9001

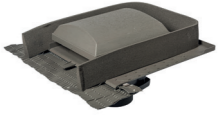

PRODUCT FEATURES

Pitched roof terminals have low resistance to airflow and incorporate condensation grooves to prevent any condensate running back down the duct. They satisfy the requirements of BS 5250 Code of Practice for the control of condensation in buildings.

TERMINALS

Terminals are designed to resist the ingress of deluge and driving rain. They have silica sand entrained in the polymeric resin surface to help weather more closely hit the surrounding tiles over time. Terminals have a smooth finish and are manufactured from ABS.

APPLICATION

- Suitable for roof pitches between 20° and 60°
- Suitable for mechanical extract and intake.

PART NUMBER	DUCT SIZE	RESISTANCE IN Pa											
		5l/s	10l/s	15l/s	20l/s	25l/s	30l/s	35l/s	40l/s	50l/s	60l/s	70l/s	80l/s
PVCTT9	Ø100mm	0.1	0.5	1.2	2.1	3.3	4.8	6.6	8.6	13.5	19.6	26.7	34.9

Ø125MM SYSTEM



— Ø100mm

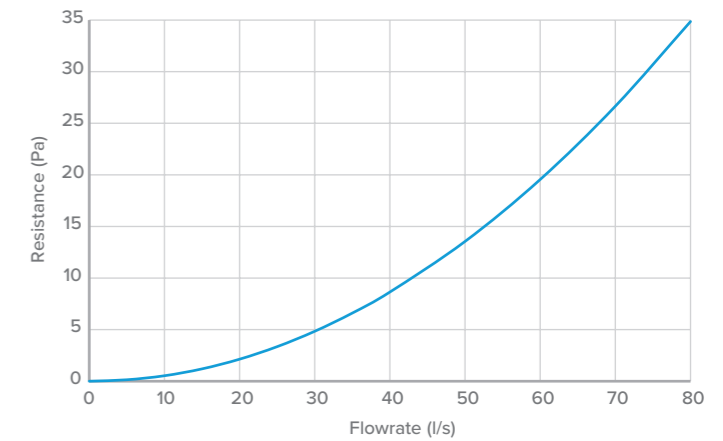

UNIVERSAL COWL

FOR FLAT ROOF ONLY

CODE	DUCT SIZE	DESCRIPTION	MATERIAL
RPC-8	Ø200mm	Steel universal roof cowl with integrated bird mesh	Galvanised steel
RPC-6	Ø150mm	Steel universal roof cowl with integrated bird mesh	Galvanised steel
RPC-5	Ø125mm	Steel universal roof cowl with integrated bird mesh	Galvanised steel
RPC-4	Ø100mm	Steel universal roof cowl with integrated bird mesh	Galvanised steel

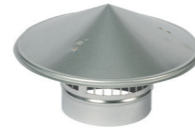

CODE	ØA MM	ØH MM	FREE AREA %
RPC-8	399	210	131
RPC-6	312	184	146
RPC-5	248	164	140
RPC-4	208	144	138

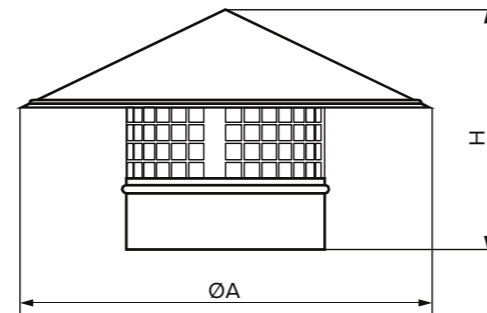

The free area is calculated minimum area given as a percentage of the duct area. In reality this area is normal 2 to 5 percent higher.

ROOF PIPE FLASHING

CODE	DUCT SIZE	DESCRIPTION	COLOUR	MATERIAL
RPF10-18	Ø200mm - Ø450mm	Roof pipe flashing for use with profiled roofing material	Black	EPDM
RPF6-11	Ø150mm - Ø275mm	Roof pipe flashing for use with profiled roofing material	Black	EPDM
RPF4-7	Ø100mm - Ø175mm	Roof pipe flashing for use with profiled roofing material	Black	EPDM
RPF3-6	Ø75mm - Ø150mm	Roof pipe flashing for use with profiled roofing material	Black	EPDM



ADVANCED OZONE RESISTANCE TESTED TO		70 hour @500 pphm
HIGH TEMPERATURE RESISTANCE TESTED TO	Intermittent	+135°C
HIGH TEMPERATURE RESISTANCE TESTED TO	Continuous	+100°C
LOW TEMPERATURE RESISTANCE TESTED TO		-55°C
COMPRESSION SET MINIMUM		25%

ROOF PIPE FLASHING KIT

CODE	SILICONE	SILVER CAPS	SCREWS	DRILL BIT	INSTRUCTIONS
RPFK	1 x 80ml clear silicone tube	10 x silver caps	10x 6.3 x 25mm SP screws	1 x 4.8mm drill bit	1x fixing instruction leaflet



SELF-SEALING WALL GRILLE

CODE	DUCT SIZE	DESCRIPTION	CONNECTION	MATERIAL	COLOUR	FLAMMABILITY RATING	MANUFACTURED TO
PVC2447WH	Ø100mm	Self-sealing wall grille	Duct	Extruded uPVC	White	UL94V0	ISO9001
PVC2447T	Ø100mm	Self-sealing wall grille	Duct	Extruded uPVC	Terracotta	UL94V0	ISO9001

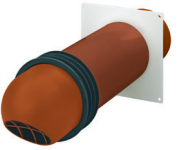

PART NUMBER	DUCT SIZE	RESISTANCE IN Pa											
		5l/s	10l/s	15l/s	20l/s	25l/s	30l/s	35l/s	40l/s	50l/s	60l/s	70l/s	80l/s
PVC4411	Ø100mm	0.0	0.3	0.8	1.6	2.6	3.8	5.2	6.7	10.3	14.4	18.9	23.7
PVC447T													

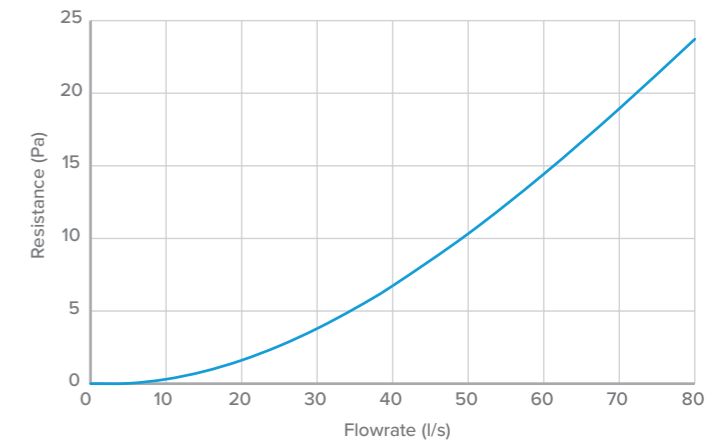
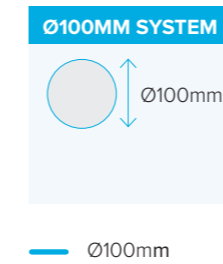

HIGH RISE COWL DIMENSIONS (MM)

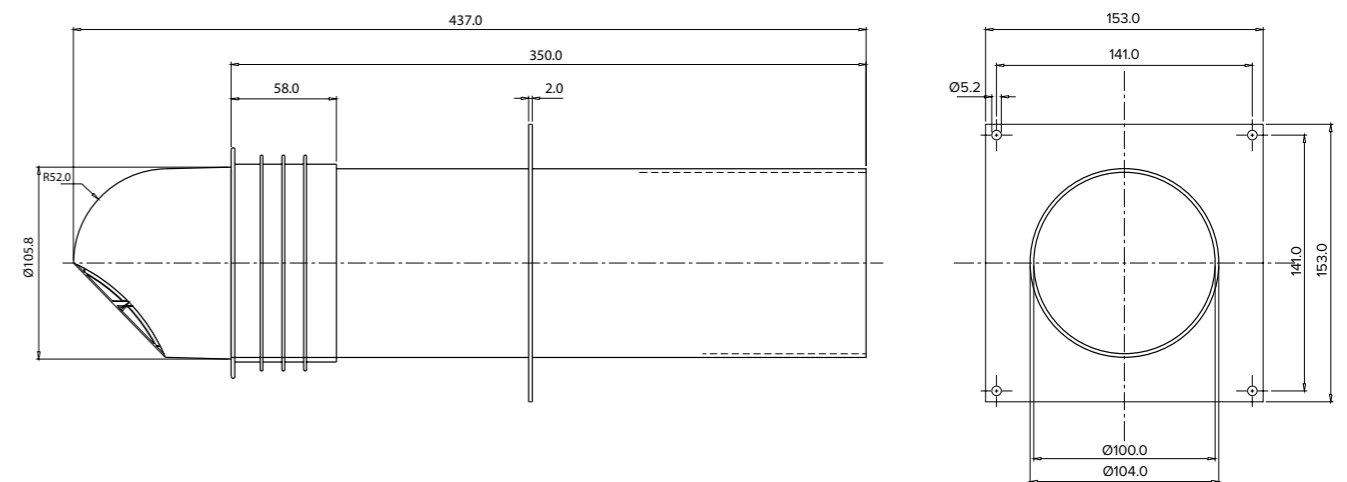

ATTENUATORS

RECTANGULAR SILENCER 220MM X 90MM

CODE	DUCT SIZE	DESCRIPTION
PVCSIL220X90-1500	220mm x 90mm	3x 500mm length rectangular duct silencers and 2x connecting pieces
PVCSIL220X90-1000	220mm x 90mm	2x 500mm length rectangular duct silencers and 1x connecting piece
PVCSIL220X90-500	220mm x 90mm	500mm length rectangular duct silencer



PART NUMBER	DUCT SIZE	RESISTANCE IN Pa											
		5l/s	10l/s	15l/s	20l/s	25l/s	30l/s	35l/s	40l/s	50l/s	60l/s	70l/s	80l/s
PVCSIL220X90-1500	220mm x 90mm	0.4	1.4	2.9	4.8	7.2	10.1	13.4	17.2	26.0	36.6	48.7	62.5
PVCSIL220X90-1000		0.3	0.9	1.9	3.2	4.8	6.7	8.9	11.4	17.3	24.4	32.5	41.7
PVCSIL220X90-500		0.1	0.5	1.0	1.6	2.4	3.4	4.5	5.7	8.7	12.2	16.2	20.8

220MM X 90MM SYSTEM

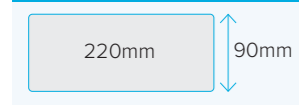

- PVCSIL220X90-1500
- PVCSIL220X90-1000
- PVCSIL220X90-500

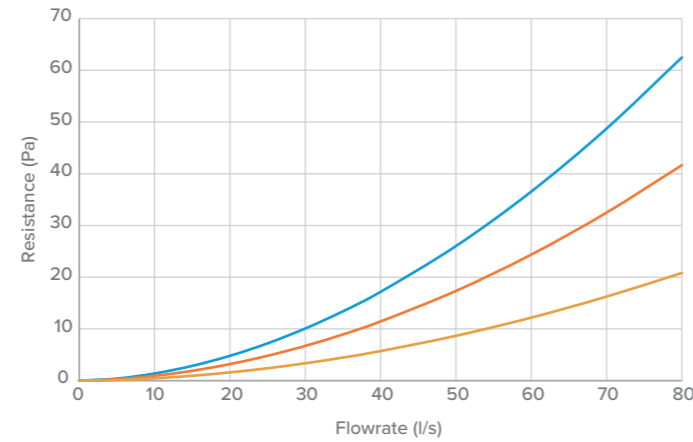

OCTAVE BAND INSERTION LOSS

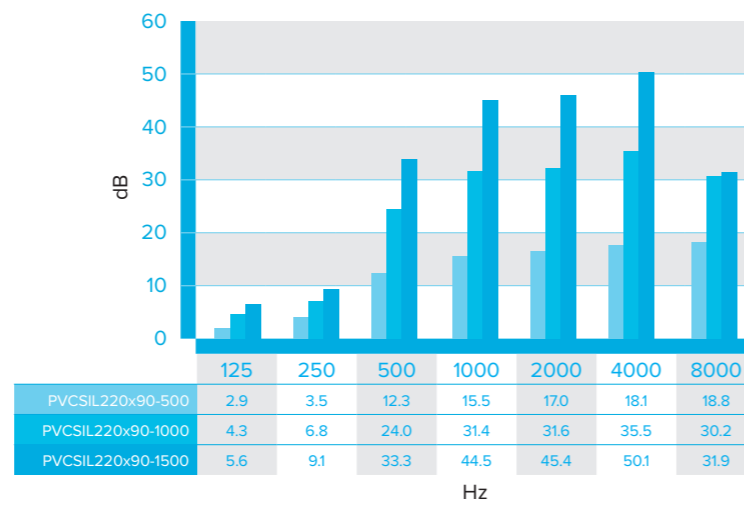

RECTANGULAR SILENCER 204MM X 60MM

CODE	DUCT SIZE	DESCRIPTION
PVCSIL-1500	204mm x 60mm	3x 500mm length rectangular duct silencers and 2x connecting pieces
PVCSIL-1000	204mm x 60mm	2x 500mm length rectangular duct silencers and 1x connecting piece
PVCSIL-500	204mm x 60mm	500mm length rectangular duct silencer



PART NUMBER	DUCT SIZE	RESISTANCE IN Pa											
		5l/s	10l/s	15l/s	20l/s	25l/s	30l/s	35l/s	40l/s	50l/s	60l/s	70l/s	80l/s
PVCSIL-1500	204mm x 60mm	1.8	5.4	10.7	17.6	26.3	36.8	49.0	63.2	97.5	140.1	191.4	251.9
PVCSIL-1000		1.2	3.6	7.1	11.8	17.5	24.5	32.7	42.2	65.0	93.4	127.6	167.9
PVCSIL-500		0.6	1.8	3.6	5.9	8.8	12.3	16.3	21.1	32.5	46.7	63.8	84.0

204MM X 60MM SYSTEM

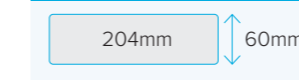

- PVCSIL-1500
- PVCSIL-1000
- PVCSIL-500

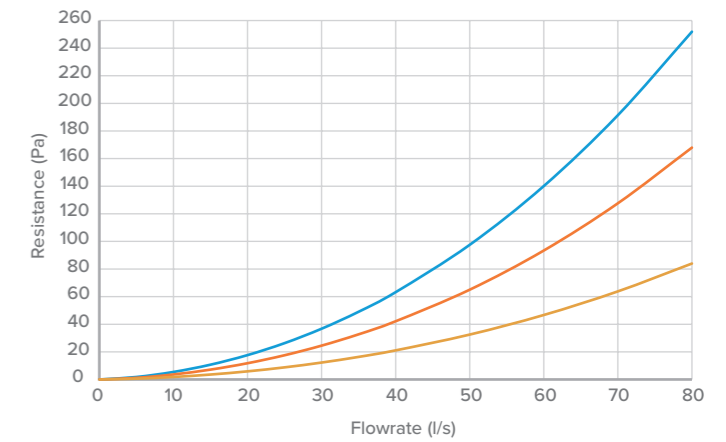

OCTAVE BAND INSERTION LOSS

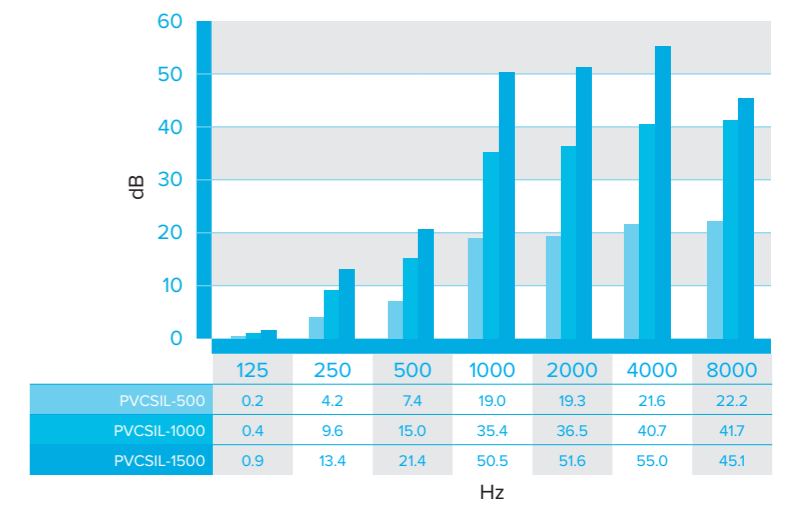

ROUND SILENCER

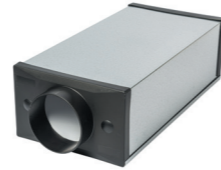

CODE	DUCT SIZE	DESCRIPTION
SIL-150	Ø150mm	600mm length in-line round duct silencer
SIL-125	Ø125mm	600mm length in-line round duct silencer
SIL-100	Ø100mm	600mm length in-line round duct silencer

PART NUMBER	DUCT SIZE	RESISTANCE IN Pa											
		5l/s	10l/s	15l/s	20l/s	25l/s	30l/s	35l/s	40l/s	50l/s	60l/s	70l/s	80l/s
SIL-150	Ø150mm	0	0	0	0	0	1	1	1	2	3	4	5
SIL-125	Ø125mm	0	0	0	0	1	1	1	2	2	4	5	7
SIL-100	Ø100mm	0	0	0	1	1	2	3	4	6	8	11	15

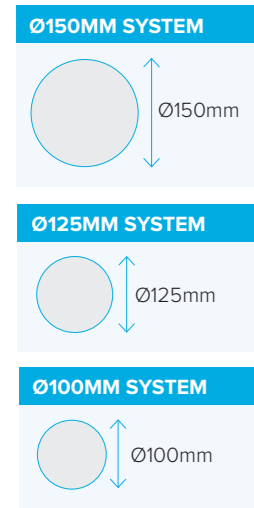

- Ø150mm
- Ø125mm
- Ø100mm

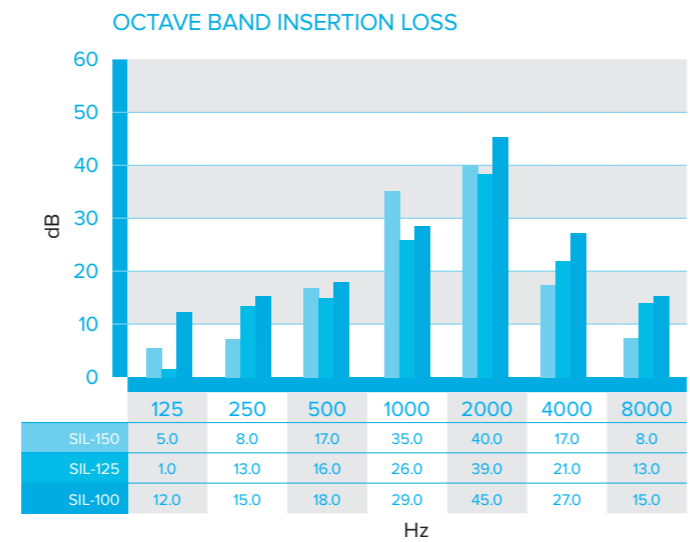
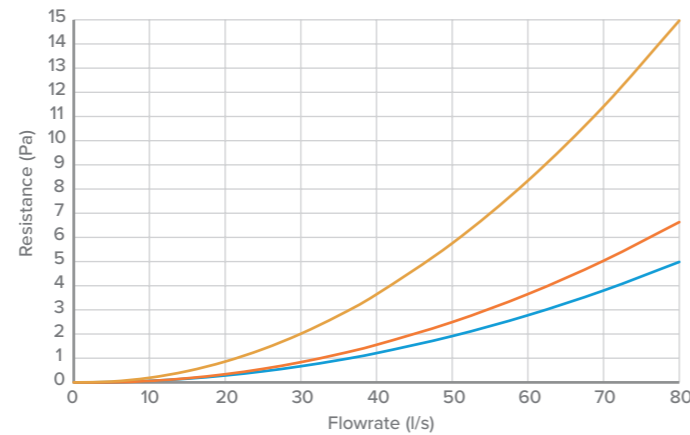

DUCT ACCESSORIES

CONDENSATION TRAP Ø125MM

CODE	DUCT SIZE	DESCRIPTION	MATERIAL	COLOUR
CONTRAP125	Ø125mm	Condensation trap	uPVC	Grey



PRODUCT FEATURES

Straight socket connector to 125mm pipe
Provides an internal trap/diverter which will collect condensation forming on the internal surface of the extract pipework

23mm connection to allow drain of the condensation to a convenient position

CONDENSATION TRAP Ø125MM DIMENSIONS (MM)

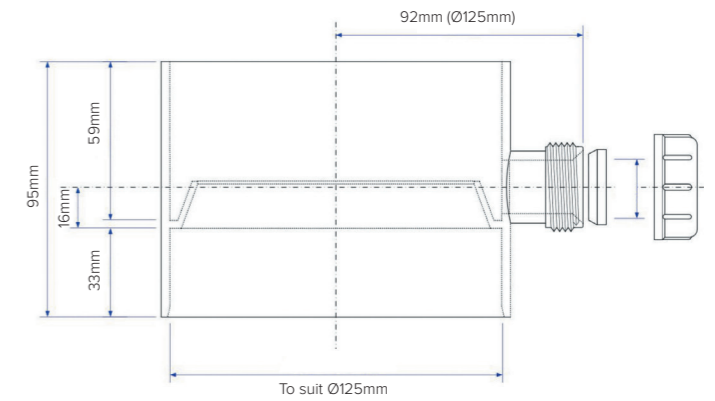

CONDENSATION TRAP Ø100MM

CODE	DUCT SIZE	DESCRIPTION	MATERIAL	COLOUR
CONTRAP100	Ø100mm	Condensation trap	uPVC	White



PRODUCT FEATURES

The CONTRAP100 Ø100mm condensation trap is manufactured from white PVC and has a minimum free areas of 5,594mm². It has a female adaptor for connection to the outside of Ø100mm ducting.

The CONTRAP100 is installed at the lowest point in vertical rises where moisture from condensation can occur. It captures any moisture running down the inside of the duct and is drained via a Ø22mm overflow pipe connector.

It is manufactured in compliance with Domestic Plastic Ductwork Specification DW/154 and does meet UL95HB flammability standard.

CONDENSATION TRAP Ø100MM DIMENSIONS (MM)

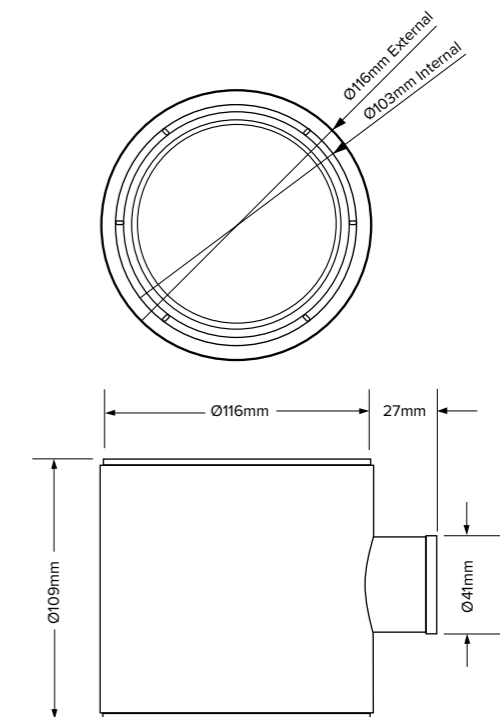

CONDENSATION DRAIN

CODE	CONNECTION	DESCRIPTION	MATERIAL	COLOUR
MVHR-DRAIN	Ø21.5mm	In-Line Condensation Drain	Polypropylene	White

Hep _v O [®] DIMENSIONS						
SIZE MM	C	E	L	W	Z	H
32mm	8.0	171.0	208.0	211.0	40.0	70.0
40mm	5.0	171.0	208.0	213.0	40.0	73.0



Notes:

1. Dimensions are nominal and may vary slightly due to compression of the rubber seals
2. When fixed to a pipe it is recommended that MHVR-DRAIN should remain accessible

DYNO TIES

CODE	DUCT SIZE	DESCRIPTION	MATERIAL	COLOUR	FLAMMABILITY RATING	TEMPERATURE RESISTANCE	
DT33	Up to Ø200mm	Nylon dyno ties	Nylon 66	Black	UL94V0	Installation: -10°C to +85°C	Operation: -40°C to +85°C



PART NUMBER	SUITABLE FOR DIAMETER	LENGTH	WIDTH	MINIMUM LOOP TENSILE
DT33	Ø270mm	920mm	9mm	80kg

OVERVIEW

Dyno ties are designed to secure flexible ducts to outlets, pipes and other fittings. Made of high strength nylon, they are easily and quickly installed.

DUCT SEALANT

CODE	PRODUCT FEATURES
PVCDEAL	Acrylic sealant suitable for internal and external use that provides a permanently flexible and long lasting seal that adheres to virtually all materials. Contains anti-fungal agent to prevent mould growth in areas of high humidity and can be overpainted.



DESCRIPTION

- ▶ **FORM** - READY TO USE THIXOTROPIC PASTE, VISCOCITY CA. 250,000CPS
- ▶ **SPECIFIC GRAVITY** - 1.65-1.69
- ▶ **ELONGATION AT BREAK (%)** - CA. 100%
- ▶ **HARDNESS (SHORE A)** - APPROXIMATELY 40
- ▶ **TACK FREE TIME** - 15 TO 60 MINS, DEPENDENT ON THICKNESS, AMBIENT TEMPERATURE AND HUMIDITY
- ▶ **FULL CURE** - 3 TO 5 DAYS, DEPENDENT ON THICKNESS, AMBIENT TEMPERATURE AND HUMIDITY
- ▶ **SOLIDS CONTENT** - 80-84%
- ▶ **SLUMP RESISTANCE** - NO SLUMP AT 25°C WHEN PLACED IN A 20MM X 10MM VERTICAL CHANNEL
- ▶ **APPLICATION TEMP. RANGE** - +4°C TO +40°C
- ▶ **SERVICE TEMP. RANGE** - (-15°C) TO +75°C
- ▶ **CHEMICAL RESISTANCE** - DILUTE ACIDS - FAIR; DILUTE ALKALINE - FAIR; ALIPHATIC HYDROCARBONS - FAIR; AROMATIC HYDROCARBONS - POOR
- ▶ **MOVEMENT ACCOMMODATION** - LOW TO MEDIUM (+/-7.5%)
- ▶ **DURABILITY** - UP TO 15 YEARS WHEN USED AS RECOMMENDED
- ▶ **SHELF LIFE** - UP TO 26 MONTHS WHEN STORED IN UNOPENED CARTRIDGES UNDER COOL DRY CONDITIONS. AVOID FROST
- ▶ **COMPATIBILITY** - CAN BE USED IN CONTACT WITH MOST BUILDING AND DECORATING MATERIALS BUT SHOULD NOT BE USED AGAINST BITUMINOUS MATERIALS
- ▶ **LIMITATIONS** - SHOULD NOT BE USED IN CONDITIONS OF CONTINUOUS IMMERSION, BELOW GROUND LEVEL, IN AREAS OF HIGH ABRASION (E.G. FLOOR JOINTS)

DUCT SEALING TAPE

CODE	TAPE THICKNESS	FOIL THICKNESS	DESCRIPTION	MATERIAL
PVC50TP45	0.060mms (without liner)	0.030mms	Duct sealing tape	Aluminium



PEEL ADHESION TO STEEL	LOOP TACK	SHEAR (STATIC)	FIRE PROTECTION	MINIMUM APPLICATION TEMP.	SERVICE RANGE	SHELF LIFE	TAPE LENGTH
1000N/M	800N/M	87 hours @ 1kg	Conforms to Class O BS476 part 7 & 6 1987	0°C	-20°C to 120°C	12 months (PSMA conditions)	45m

PRODUCT FEATURES

A 30 Micron soft-tempered bright aluminium foil. Coated with high tack pressure adhesive which has excellent UV light resistance on a white glassine liner.

APPLICATIONS

This product is recommended where a moisture barrier and cold weather performance is required.

WARRANTIES

These figures are average values and should not be regarded as maximum or minimum values for specification purpose.

The purchaser shall be responsible for determining the suitability of this product.

Goods which prove to be defected through faulty material or workmanship must be returned to us carriage paid.

These will be replaced or credited. We shall not be liable for consequential damage incurred in the use of this material.

ACOUSTIC INTUMESCENT MASTIC

CODE	SLUMP	DMAX JOINT WIDTH	WORKING TIME	SKIN OVER TIME	TACK FREE TIME
PVCFSEAL	Nil in joints up to 50mm	50mm	10 minutes	10 minutes	15 minutes

JOINT MOVEMENT	CURE RATE	FIRE TEST TEMP.	CLEANING	PACKAGING
+/- 20% of original size	3mm/24hrs at 50% relative humidity +23%	1160°C - intumescent @ ca. 135°C	Uncured with a dampened cloth	C3 plastic cartridges



PRODUCT FEATURES

Five hour rated, one part, emulsion acrylic-based, intumescent acoustic sealant that gives a firm, yet flexible seal to joints in a variety of fire-rated structures.

Tested following the principles of BS EN 1366-4:2006 as detailed in Warrington Fire Research Report No. 181967 (May 2009). Acoustic rated to BS EN ISO 140/3.

Tested for air permeability to EN13141-1. The product, in suitably designed joint will resist the passage of fire for up to 5 hours.

The selected fillers used in this formation also make it suitable as an acoustic sealant. Product has a service life expectancy in excess of 25 years.

FIRE TEST RESULTS - WALL SPECIMENS

SPECIMEN	GAP FACE MATERIAL COMBINATION	WIDTH/DEPTH (MM)	BACKING MATERIAL	INTEGRITY	INSULATION
E	Aerated concrete/steel	30/15mm	PE open cell foam	300mm	91mm
F	Aerated concrete/aerated concrete	20/10mm	PE open cell foam	300mm	300mm
G	Aerated concrete/aerated concrete	10/10mm	PE open cell foam	300mm	#
H	Aerated concrete/aerated concrete	30/10mm	PE open cell foam	300mm	215mm

FIRE TEST RESULTS - FLOOR SPECIMENS

SPECIMEN	GAP FACE MATERIAL COMBINATION	WIDTH/DEPTH (MM)	BACKING MATERIAL	INTEGRITY	INSULATION
A	Aerated concrete/aerated concrete	30/15mm	PE open cell foam	300mm	66mm
B	Aerated concrete/aerated concrete	20/10mm	PE open cell foam	300mm	13mm
C	Aerated concrete/aerated concrete	10/10mm	PE open cell foam	300mm	#
D	Aerated concrete/aerated concrete	50/25mm	PE open cell foam	300mm	214mm

HANGING BANDING

CODE	DESCRIPTION	MATERIAL	SIZE	ROLL LENGTH	COLOUR
PVCBAND	Perforated duct banding	Galvanised steel	12mm	10mm	White



JUBILEE CLIP

CODE	DUCT SIZE	DESCRIPTION	MATERIAL	BAND	
				WIDTH	THICKNESS
J/CLIP SIZE6	Ø60mm - Ø175mm	Jubilee clip duct clamp	Stainless steel 430 band, coated steel locking device	9mm	0.6mm



OVERVIEW

Jubilee clips consist of a continuous serrated banding with rounded edges. The tightening device consists of a tilting housing and screw.

This system allows a quick and easy clamping of ducts thanks to the automatic locking that forms the diameter.

Screw for locking device is hexagonal, cruciform and slotted head.

JUBILEE CLIP TECHNICAL DIAGRAM

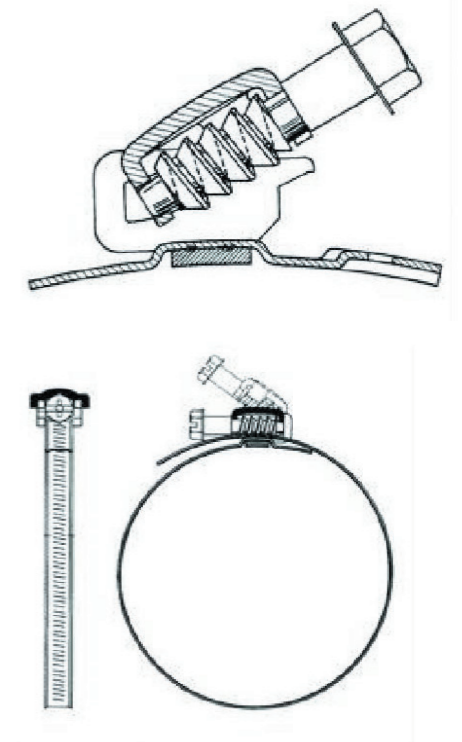

METAL DUCT SEALANT

CODE	DESCRIPTION
GALVSEAL	Sealant for galvanised metal ducting



OVERVIEW

High performance galvanised metal duct sealant. Is a solvent-free adhesive and sealant specifically designed for sealing high velocity duct work in heating and ventilation systems.

APPROVALS / STANDARDS

Certified under the harmonised European standard EN15651 for façade interior applications in compliance with the Construction Product Regulation.

DESCRIPTION

- ▶ **CHEMICAL BASE** - ACRYLIC WATER-BASED PASTE
- ▶ **PACKAGING** - 295ML CARTRIDGE
- ▶ **COLOUR** - GREY
- ▶ **SHELF LIFE** - USE WITHIN 36 MONTHS
- ▶ **STORAGE CONDITIONS** - STORE IN COOL DRY CONDITIONS BETWEEN 5°C AND 25°C, PROTECT FROM FROSTY
- ▶ **DENSITY** - 1.64 - 1.70 G/CM³
- ▶ **SOLIDS CONTENT** - ~80%

TECHNICAL INFORMATION

- ▶ **SHORE A HARDNESS** - APPROXIMATELY 30
- ▶ **ELONGATION AT BREAK** - 250-300% DIN53504
- ▶ **MOVEMENT CAPABILITY** - LOW TO MEDIUM (+/- 5%)
- ▶ **CHEMICAL RESISTANCE** - DILUTE ACIDS - FAIR; DILUTE ALKALINE - FAIR; ALIPHATIC HYDROCARBONS - FAIR AROMATIC HYDROCARBONS - POOR
- ▶ **SERVICE TEMP.** - -15°C TO 75°C

APPLICATION INFORMATION

- ▶ **AMBIENT AIR TEMP.** - +4°C TO +40°C
- ▶ **CURING TIME** - 3 TO 5 DAYS, DEPENDENT ON THICKNESS, AMBIENT TEMPERATURE AND HUMIDITY
- ▶ **TACK FREE TIME** - 15 TO 60 MINS, DEPENDENT ON THICKNESS, AMBIENT TEMPERATURE AND HUMIDITY



MINERAL WOOL DUCT WRAP

CODE	DESCRIPTION	THICKNESS OF ROLL MM	LENGTH OF ROLL MM	WIDTH OF ROLL MM	ROLLS PER PACK	AREA PER PACK M ²
779165	Duct wrap	25mm	5000mm	1000mm	2	10m ²

CODE	DESCRIPTION	T °C	THERMAL CONDUCTIVITY				
			10	50	100	150	200
779165	Duct wrap	λ (W/mK)	0.034	0.040	0.050	0.063	0.079



OVERVIEW

Lightweight, flexible insulation roll, faced with reinforced aluminium foil.

DENSITY

The nominal density is 45kg/m³.

FIRE

Classified A1 in accordance with BS EN 13501-1 and fully comply with the definitions of non-combustible in all UK and Ireland Building Regulations.

WATER VAPOUR RESISTANCE

When suitably taped, the aluminium foil gives water vapour resistance of approx. 1000MNs/g.

SERVICE TEMPERATURE AND LIMITING SURFACE TEMPERATURE

Can be used for service temperatures of up to 230°C. The limiting outer foil face temperature is 80°C to maintain facing bond strength.

ACOUSTICS

It is sometimes desirable to improve the acoustic insulation on pipes, especially those in which gases, fluids or particle solids are transported at high velocities. The use of duct wrap can considerably improve the level of environmental sound.

PH NEUTRALITY

Chemically compatible with all types of pipes, equipment and fittings. (Guidance is given in BS5970 regarding the treatment of austenitic stainless steel pipework and fittings). Stone wool insulation is chemically inert. A typical aqueous extract is neutral or slightly alkaline (pH 7 to 9.5).

DURABILITY

Effective protection for the lifetime of the ducts it insulates.

BIOLOGICAL

Biological
Naturally inert, rot-proof material that does not encourage or support the growth of fungi, moulds or bacteria. Stone wool does not offer sustenance to insects or vermin.

FIRE DAMPER AIR VALVE

CODE	DESCRIPTION	DUCT SIZE	MATERIAL	COLOUR	MIN. OPERATING TEMP	MAX. OPERATING TEMP
V-FD125	Fire-rated damper air valve	Ø125mm	Intumescent epoxy powder-coated steel	White	-15°C	+60°C



PART NUMBER	DUCT SIZE	RESISTANCE IN Pa											
		5l/s	10l/s	15l/s	20l/s	25l/s	30l/s	35l/s	40l/s	50l/s	60l/s	70l/s	80l/s
V-FD125	Ø150mm	2.6	5.9	11.2	18.2	27.0	37.5	49.5	63.1	94.5	131.0	172.1	217.1

Resistances based on a 10mm opening

Ø125MM SYSTEM



Ø125mm

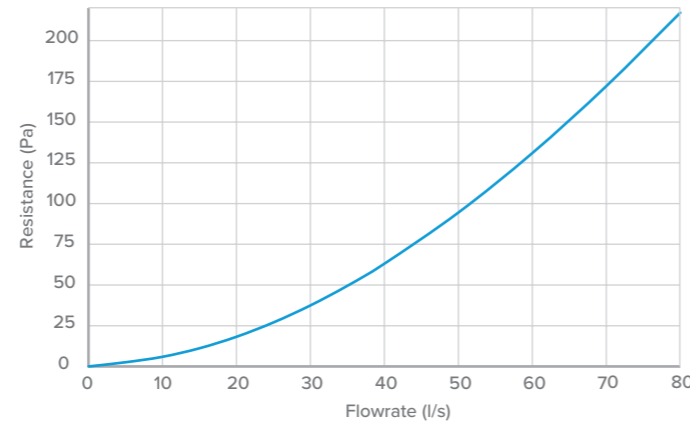

BACK VIEW (FIXING BODY)

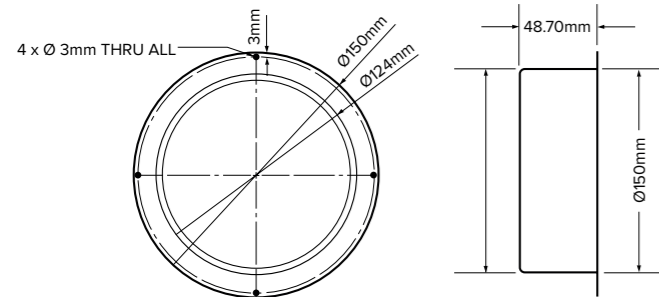

FEATURES

- Meets the requirement of Building Regulations Approved Document B
- Maintains integrity of fire rated ceilings for up to 60 minutes
- Alternative to more expensive fire dampers
- Fits in exactly the same way as a standard metal air valve
- Air flow is unaffected
- Easy to retrofit in place of existing metal air valves
- Highly cost-effective

FIRE TESTING

- Tested for 60 minutes according to BS EN 1365-2 fire resistance tests for loadbearing elements - floors and roofs

FRONT VIEW (CEILING VALVE)

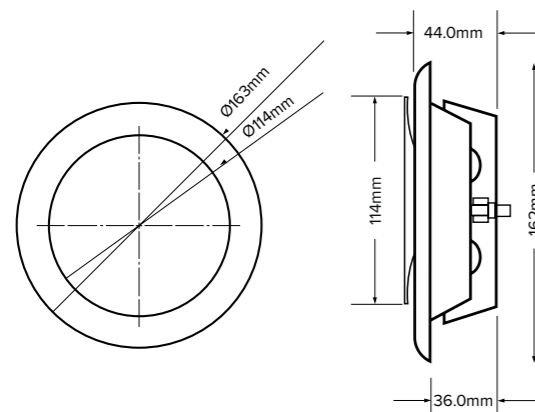

FIRE WRAP

CODE	DUCT SIZE	DESCRIPTION	NORMAL THICKNESS	NOMINAL EXTERNAL WIDTH/DIAMETER	NOMINAL EXTERNAL HEIGHT	LENGTH	FIRE RATING
FW220X90T	220mm x 90mm	Fire-rated duct wrap	10-15mm	244mm	124mm	180mm	Up to E1120
FW204X60T	204mm x 60mm	Fire-rated duct wrap	10-15mm	228mm	89mm	180mm	Up to E1120
FW110X54T	110mm x 54mm	Fire-rated duct wrap	10-15mm	134mm	83mm	180mm	Up to E1120

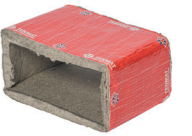

CODE	DUCT SIZE	DESCRIPTION	NORMAL THICKNESS	NOMINAL EXTERNAL WIDTH/DIAMETER	NOMINAL EXTERNAL HEIGHT	LENGTH	FIRE RATING
PVC688T	Ø150mm	Fire-rated duct wrap	20mm	200mm	-	280mm	Up to E1120
PVC588T	Ø125mm	Fire-rated duct wrap	15mm	160mm	-	280mm	Up to E1120
PVC488T	Ø100mm	Fire-rated duct wrap	15mm	134mm	-	280mm	Up to E1120



FEATURES

- CE Marked
- Simple and quick to install, no screws or support needed
- No metal sleeving required
- Available to fit most common duct sizes
- Can be tightly fitted against ceiling soffit due to low-profile design
- Assessed for use in series around multiple duct penetrations

Assessed for installation in:

- Plasterboard clad steel stud partitions
- Single layer and double layer partitions
- 30, 60 and 120 minute walls
- Masonry walls
- Ablative coated fire blatts
- Up to 3No. ducts side by side
- Up to 2No. stacked ducts
- External wall applications

FIRE TESTING

Full scale BS EN1366-3 fire resistance tests for service installations, penetration seals. Uncapped/Uncapped (U/U) tested, 30, 60 and up to 120 minute fire rated.

Please ensure fire wraps are only applied to straight PVC ducting lengths.

For further information, please contact Nuair for technical data and installation documents.

RADIAL RADIAL RANGE

RADIAL DUCT LENGTH

CODE	DUCT SIZE	DESCRIPTION
NRDD75-B25M	Ø75mm	Semi-Rigid Radial Duct (Blue) - 25m Length
NRDD75-B50M	Ø75mm	Semi-Rigid Radial Duct (Blue) - 50m Length

90° BEND

PART NUMBER	DUCT SIZE	DESCRIPTION
NRDD75-90	Ø75mm	Semi-Rigid Radial 90° Bend
NRDD75-CON	Ø75mm	Semi-Rigid Duct Connector

MANIFOLD BOX

PART NUMBER	DUCT SIZE	DESCRIPTION
NRDD75-MAN-150	Ø150mm, Ø75mm	Manifold Box (Round)
NRDD75-MAN-220	220mm X 90mm, Ø75mm	Manifold Box (Rectangular)
NRDD75-CON-CAP	Ø75mm	Manifold Protective Caps
NRDD75-RDLAB	-	Manifold Extract & Supply Label Kits

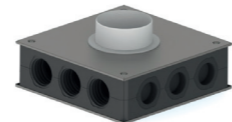
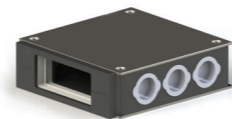

RADIAL IN-LINE ADAPTOR

CODE	DUCT SIZE	DESCRIPTION
NRDD75-RDA-3FC	220mm X 90mm to Ø75mm	In-Line Adaptor 220 x 90mm Rectangular to 3 x Ø75mm Round
NRDD75-RDA-3FA	204mm X 60mm to Ø75mm	In-Line Adaptor 204 x 60mm Rectangular to 3 x Ø75mm Round



PART NUMBER	DUCT SIZE	RESISTANCE IN Pa				
		8l/s	18l/s	15l/s	21l/s	30l/s
NRDD75-RDA-3FC	Rect to Round (A)	0.1	0.6	1.0	2.2	4.3
	Round to Rect (A)	0.6	1.3	1.7	3.5	6.5
NRDD75-RDA-3FA	Rect to Round (B)	-0.3	-0.2	-0.2	1.6	2.7
	Round to Rect (B)	1.0	2.2	2.7	5.3	10.3

90° VERTICAL BEND ADAPTOR

PART NUMBER	DUCT SIZE	DESCRIPTION
NRDD75-RDA-3FV90	220mm x 90mm to Ø75mm	220 x 90mm Rectangular to 3 x Ø75mm Round Vertical Bend Adaptor

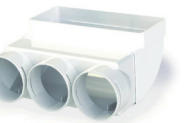

PART NUMBER	DUCT SIZE	RESISTANCE IN Pa				
		8l/s	18l/s	15l/s	21l/s	30l/s
NRDD75-RDA-3FV90	Rect to Round (A)	0.4	1.0	1.4	3.2	5.6
	Round to Rect (A)	0.7	1.6	2.0	4.2	8.3

90° HORIZONTAL BEND ADAPTOR

PART NUMBER	DUCT SIZE	DESCRIPTION
NRDD75-RDA-3FH90	220mm x 90mm to Ø75mm	220 x 90mm Rectangular to 3 x Ø75mm Round Horizontal Bend Adaptor



PART NUMBER	DUCT SIZE	RESISTANCE IN Pa				
		8l/s	18l/s	15l/s	21l/s	30l/s
NRDD75-RDA-3FH90	Rect to Round (A)	0.4	1.0	1.4	3.2	5.6
	Round to Rect (A)	0.7	1.6	2.0	4.2	8.3

T-PIECE ADAPTOR

PART NUMBER	DUCT SIZE	DESCRIPTION
NRDD75-RDA-6T	220mm x 90mm to Ø75mm	T-Piece Adaptor 220 x 90mm Rectangular to 6 x Ø75mm Round Radial Sockets
NRDD75-RDA-6TB	220mm x 90mm to Ø75mm	T-Piece Adaptor 220 x 90mm Rectangular to 6 x Ø75mm Round Radial Sockets, 3 from Branch
NRDD75-RDA-3T	220mm x 90mm to Ø75mm	T-Piece Adaptor 220 x 90mm Rectangular to 3 x Ø75mm Round Radial Sockets
NRDD75-RDLAB	-	Manifold Extract & Supply Label Kits

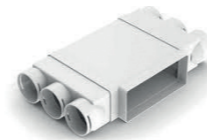

PART NUMBER	DUCT SIZE		RESISTANCE IN Pa			
			0l/s	10l/s	20l/s	30l/s
NRDD75-RDA-6T	220mm x 90mm to Ø75mm	Rect to Round (A)	0.0	1.0	2.7	5.2
		Round to Rect (A)	0.0	-0.7	-1.4	-2.2
NRDD75-RDA-6TB	220mm x 90mm to Ø75mm	Rect to Round (B)	0.0	1.1	3.3	6.5
		Round to Rect (B)	0.0	-0.6	-1.1	-1.9
NRDD75-RDA-3T	220mm x 90mm to Ø75mm	Rect to Round (C)	0.0	0.6	1.5	2.6
		Round to Rect (C)	0.0	-0.4	-1.0	-1.8

RADIAL PLENUM

PART NUMBER	DUCT SIZE	DESCRIPTION
NRDD75-RDA-3R90-150	Ø150mm to Ø75mm	Ø150mm Round to 3 x Ø75mm Round Plenum
NRDD75-RDA-3R90-125	Ø125mm to Ø75mm	Ø125mm Round to 3 x Ø75mm Round Plenum



PART NUMBER	DUCT SIZE		RESISTANCE IN Pa				
			8l/s	18l/s	15l/s	21l/s	30l/s
NRDD75-RDA-3R90-150	Ø150mm to Ø75mm	Rect to Round (A)	0.6	1.3	1.8	3.9	7.3
		Round to Rect (A)	1.1	1.9	2.3	4.8	9.7
NRDD75-RDA-3R90-125	Ø125mm to Ø75mm	Rect to Round (B)	0.5	1.4	1.7	3.7	7.3
		Round to Rect (B)	1.5	2.9	3.7	7.2	14.3

RADIAL FIRE SLEEVE

PART NUMBER	DUCT SIZE	DESCRIPTION
NRDD75-RDA-FSK	-	RDA Adaptor Products Fire Stopping Sleeve
NRDD75-RDF575	-	Semi Rigid Duct Fire Stopping Sleeve



RADIAL ANCILLARIES

PART NUMBER	DUCT SIZE	DESCRIPTION
NRDD75-RDCLIP75	Ø75mm	Duct Clips Ø75mm - Pack of 10 x
NRDD75-RDI-25X5M	-	Insulation for Ø75mm Semi-Rigid Duct
NRDD75-RDA-CSK3	-	Adaptor Spares - 2 x Blanking Caps, 3 x Clips and 3 x Seals
NRDD75-RDA-CSK6	-	Adaptor Spares - 4 x Blanking Caps, 5 x Clips and 6 x Seals



RESIDENTIAL

WWW.NUAIRE.CO.UK/RESIDENTIAL

COMMERCIAL

WWW.NUAIRE.CO.UK/COMMERCIAL

INTERNATIONAL

WWW.NUAIRE.CO.UK/INTERNATIONAL



WESTERN INDUSTRIAL ESTATE | CAERPHILLY | CF83 1NA
T 029 2085 8500 **F** 029 2085 8555 **E** INFO@NUAIRE.CO.UK
WWW.NUAIRE.CO.UK

v2.0 May 2021
Part code: 671974UG